

Pin Nails

23Ga. \varnothing 0.64mm & 21Ga. \varnothing 0.84mm
Headless and Micro head
Silver, Gold, and Pale goldenrod
Stainless steel are available

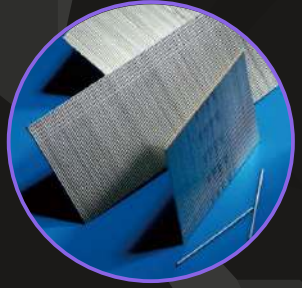

■ Clear nail point direction



■ Flat and Flexible



■ Customized packages

T Nails, Flooring Cleats

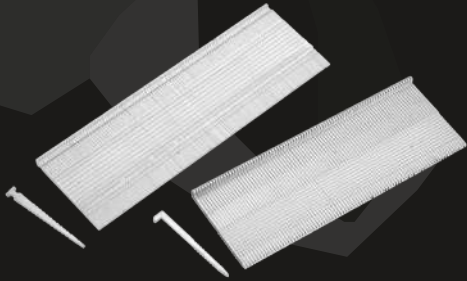

Flooring cleats and power nails

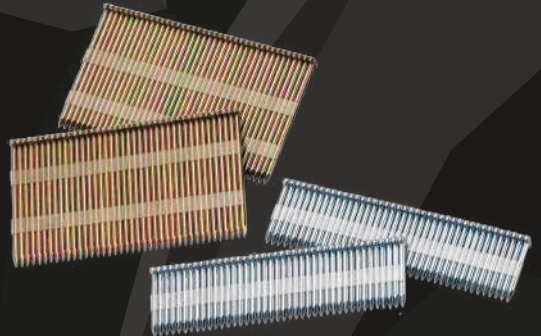

Taped Type High & Low Carbon Steel T Nails

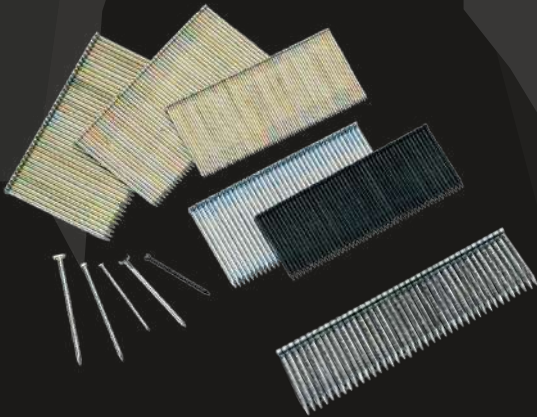

Glued Type High and Low Carbon Steel T Nails

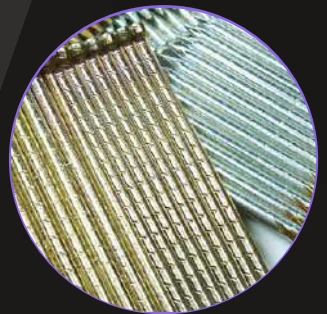

■ Nail's shank with deep groove

12 - 23 GA. Staples and Special Staples

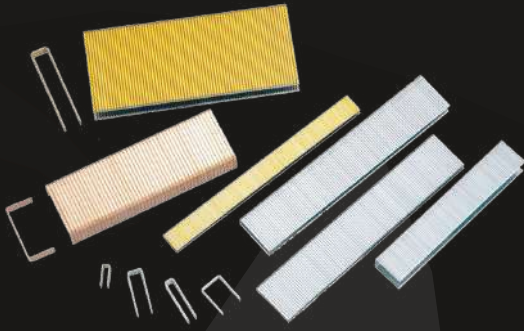

12-23 GA. Fine Wire / Medium Wire / Heavy Duty Staples

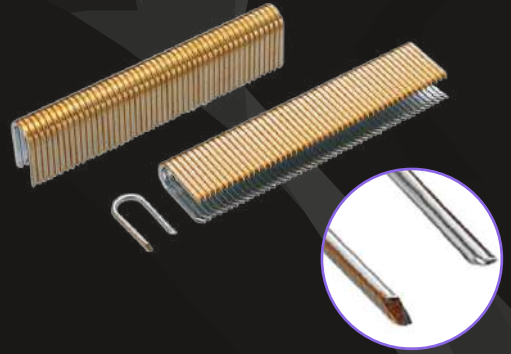

U Staples



Divergent Point Staples

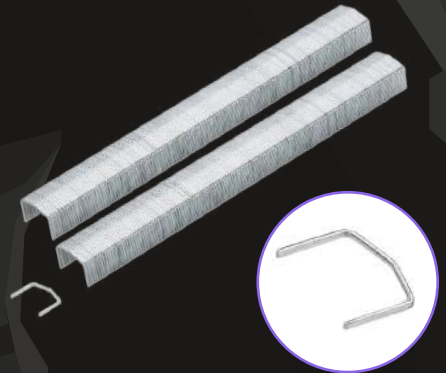

Power Crown Staples

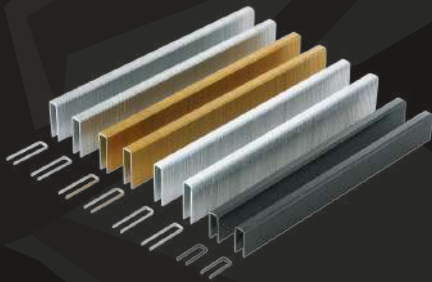

Staples With Different Color Coating

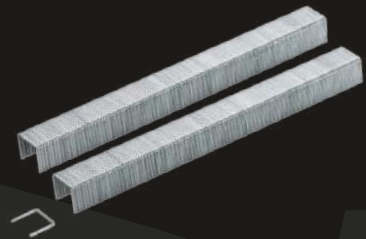

Office Staples
For Hammer Tacker & Stationery

Plastic Nails / Staples, Aluminum Staples

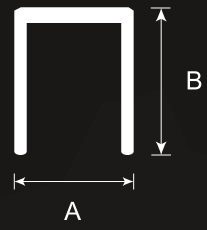
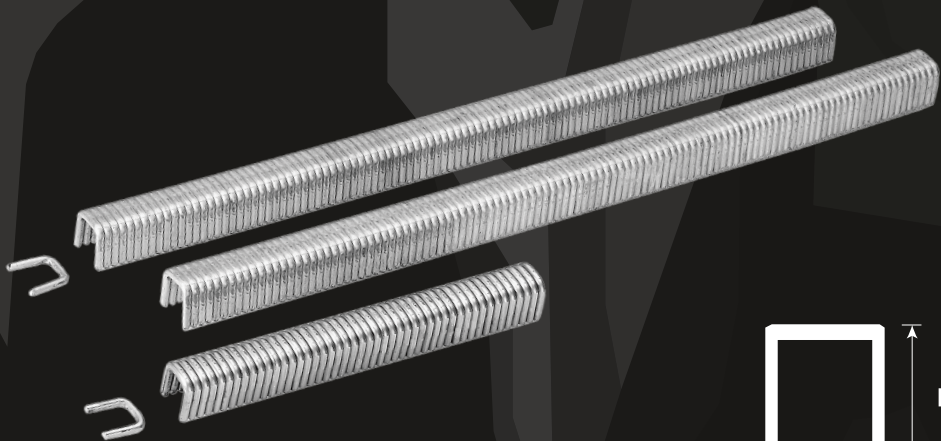
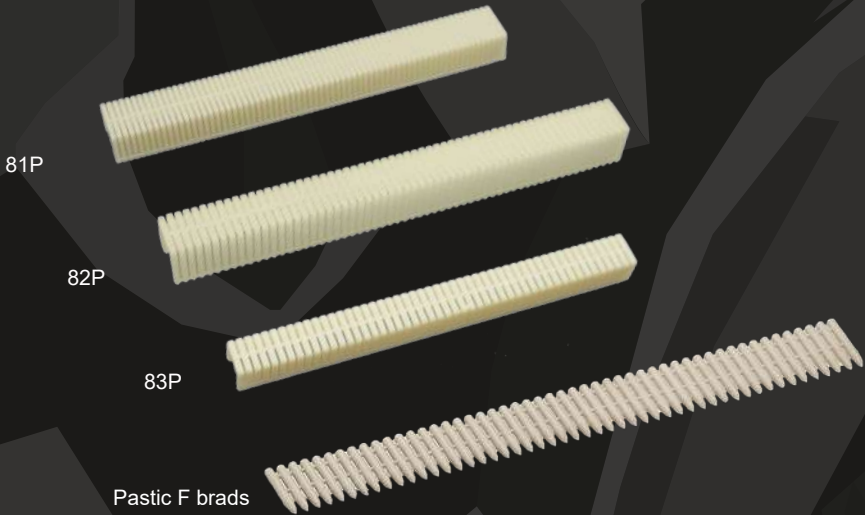

For Max Packner HR-PSII Hermetic Bag Sealer

Model No	711	713	506
Crown(A)	7 mm	7 mm	8 mm
Length(B)	11 mm	13 mm	12 mm

Carton Closing Staples



T Series Carton Staples



I Series Carton Staples

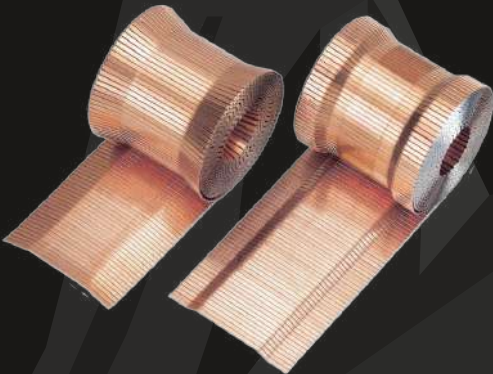

Rolled Carton Staples



S Series Carton Staples

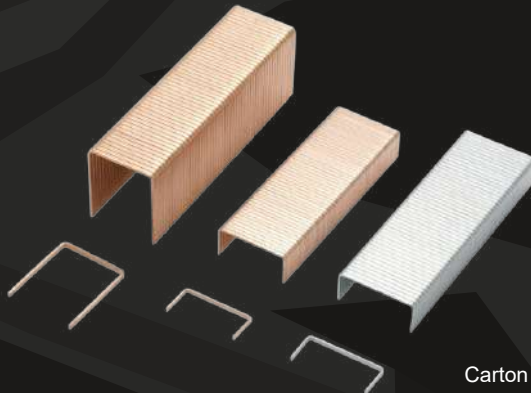

Carton Closing Staples



Cartridge Wedges / V Nails / Frame Wedges

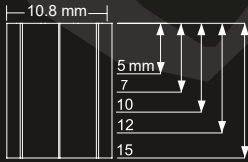
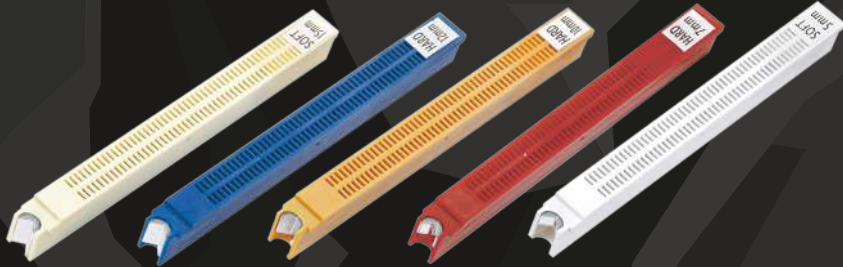

ALFA

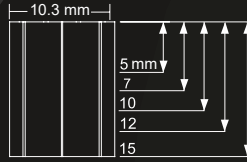

CASSESE



Cartridge Wedges - Soft / Hard Type : 5, 7, 10, 12, 15 mm

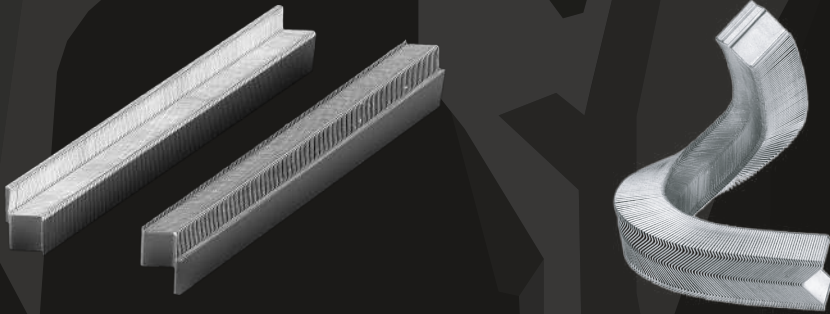

Hard V Nails & Soft V Nails-AL / UNI TYPE

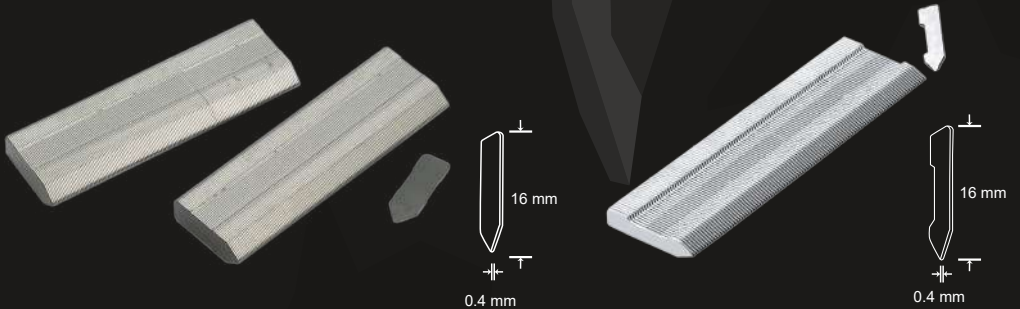

Flexipoints & Rigidpoints

Arrow Head Tab - Fletscher type

Plastic / Wire Strip Nails

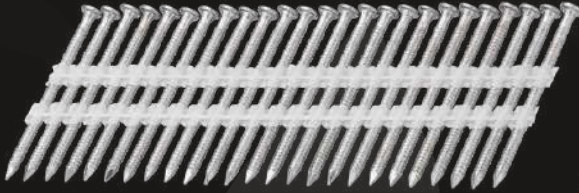

35° Anchoring plastic strip nails (Big Head)



Barbed shank strip nails

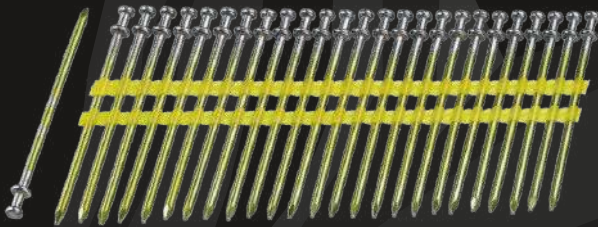

Double head plastic strip nails

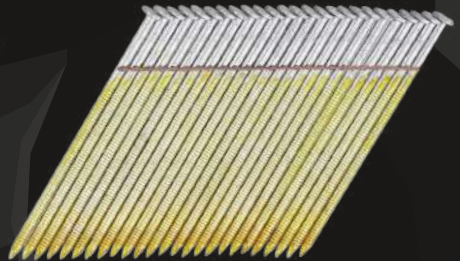

Single wire strip nails



DA nails



Hog Rings

C Rings, D Rings, Omega Rings

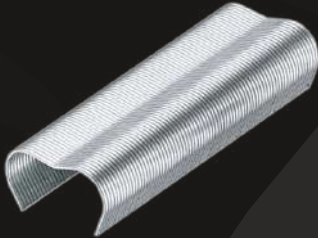

HR22 For Rapid Garden HR22

▪ Crown : 36.8 mm
Ø 1.2 x 1.3 mm

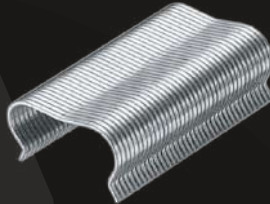

E40 For SIMES MOD 150

▪ Crown : 39 mm
Ø 2 mm

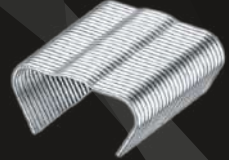

VR38 For Rapid Garden Plier GP238

▪ Crown : 38 mm
Ø 1.3 mm

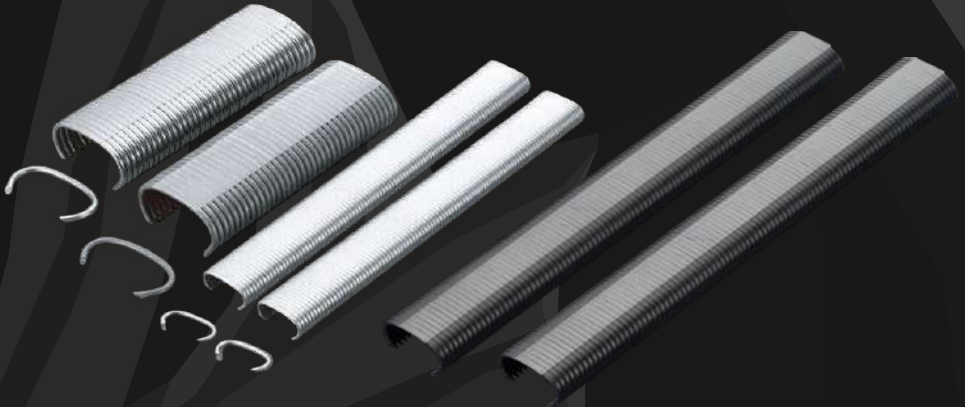

C ring



Omega Ring

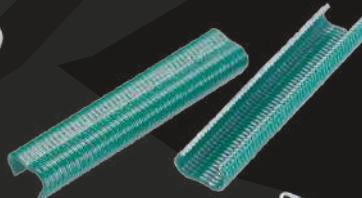

D Ring

- Material: Galvanized (Zinc Plated), Galfan (Zinc Aluminum), Stainless Steel, Aluminium
- Finishment: Green / Grey / Black PVC coated



Brad Nails

15GA, 16GA, 18GA. Angle finish nails and brads



▪ Colored Head Brads

- Customized color boxes
- Plastic box and cardboard box

Coil Nails

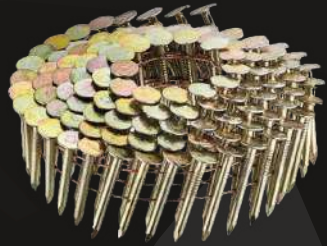

Roofing coil nail

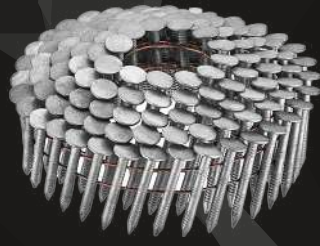

Ring bright



Coil screw

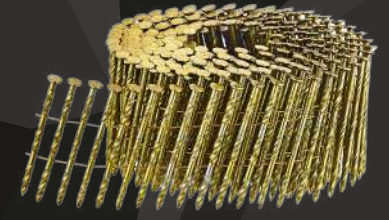

Screw bright

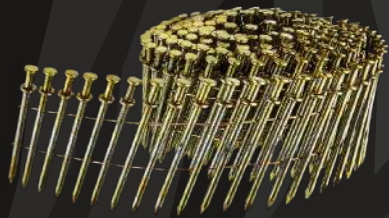

Duplex head

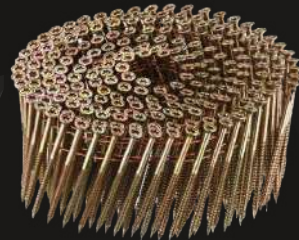

Hex head, torx recess

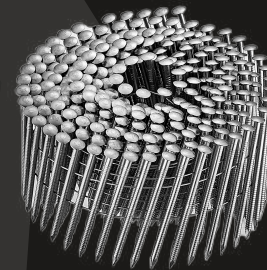

Dome head ring

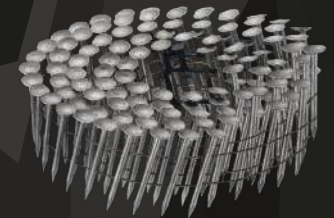

PC Drywall



Hot dip galvanized (FAP Nails)



Ballistic (Scrail shank)

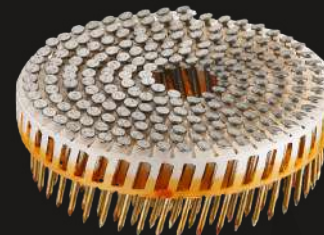

15° plastic sheet coil nails

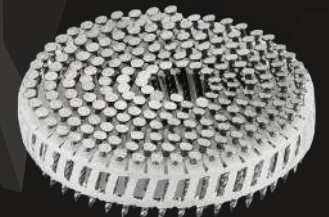

Screw shank

Paper Strip Nails



■ Customized color available

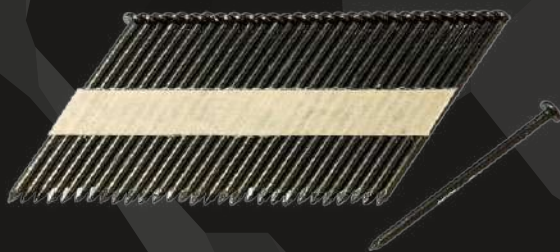

34° Positive placement nails

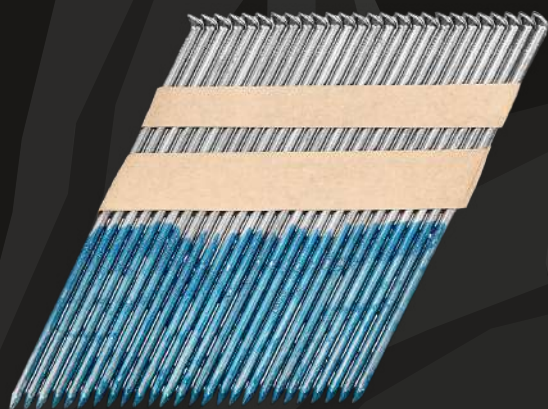

34° D-head nails 4.6x160mm

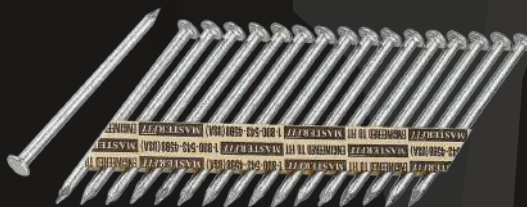

Round head paper strip nails



Metal connecting nails

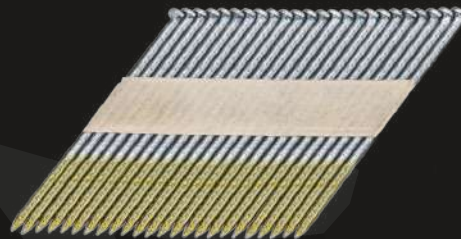
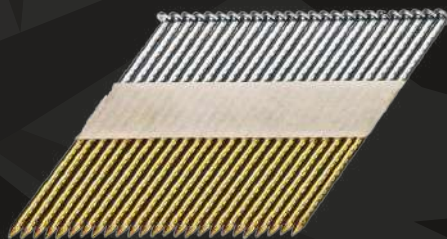

Plastic Collated Concrete Pins



PCS / PCK
 0 deg. straight heated plastic collated concrete nails
 With stepped smooth / knurling shank

- Nail shank dia.: 3.0 / 2.7 mm
- Nail head dia.: 6.4 mm



DCN
 15 deg. plastic collated concrete nail
 With mechanical galvanized and smooth ballistic shank
 Suitable for Dewalt DCN890

- Nail shank dia.: 2.6 mm
- Nail head dia.: 6.15 mm



PDC
 Plastic collated concrete pins for gas nailer
 With yellow or white Zinc coating and smooth shank

- Nail shank dia.: 2.6 mm
- Nail hed dia.: 6.3 mm



GX100, GX120
 0 deg. straight plastic collated concrete nails
 With smooth ballistic shank
 Suitable for Hilti GX100, GX120

- Nail shank dia.: 2.7 / 3.0 mm
- Nail head dia.: 6.30 mm



PDC
 Plastic collated concrete pins for gas nailer
 With black coating and smooth shank

- Nail shank dia.: 2.6 mm
- Nail head dia.: 6.3 mm



BX3
 0 deg. straight plastic collated concrete nails
 With smooth ballistic shank
 Suitable for Hilti BX3

- Nail shank dia.: 3.0 mm
- Nail head dia.: 6.30 mm



DNC
 Plastic collated nails (For P.A.T Tools)

- Shank dia: 3.7mm
- Nail head dia.: 8.0 mm



C5
 0 deg. straight plastic collated concrete nails
 With smooth ballistic shank
 Suitable for Hilti BX3

- Nail shank dia.: 3.0 / 2.7 mm
- Nail head dia.: 6.30 mm

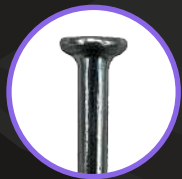

Smooth shank

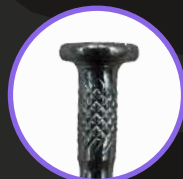

Knurling shank



Stepped shank



No Stepped shank



Pinched point



Ballistic point