

# Fine Wire Staplers

Model No: 8016J,8416J,1416J,6416J,9516J,SNCF16J

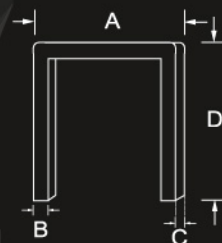

L x W x H	225x45x145 mm
Weight	0.83 kgs



Model No	Gauge	Crown(A)	Width(B)xThickness(C)	Length(D)	Capacity
8016J	21 GA	12.90 mm	0.95 x 0.65mm	4~16 mm	160 pcs
8416J	21 GA	12.20 mm	1.00 x 0.55 mm	4~16 mm	160 pcs
1416J	22 GA	10.08 mm	0.70 x 0.60 mm	4~16 mm	160 pcs
6416J	22 GA	12.50 mm	0.75 x 0.55 mm	4~16 mm	160 pcs
9516J	21 GA	12.50 mm	1.25 x 0.50 mm	4~16 mm	160 pcs
SNCF16J	21 GA	12.80 mm	1.25 x 0.50 mm	4~16 mm	160 pcs

## APPLICATION

- Upholstery
- Wooden cases
- Paper board
- Toys
- Window shade
- Cabinet backs
- Furniture backs

## FEATURES

- Comfortable handle with rubber
- Strong and light-weight die cast housing
- Fast and easy down loading

# Rear Exhaust Upholstery Stapler With Single Firing



## APPLICATION

- Furniture
- Upholstery
- Automotive vinyl
- Interior
- Trimming
- House decoration
- Carpet edge

## FEATURES

- Compact size
- Powerful
- Light weight
- One hand manual rear latch (easy loading)
- Rear air exhaust and anti dirt on workpiece
- 30~40% lower air consumption than other competitors
- Durable driver unit with POM material

L x W x H	216x38x140 mm
Weight	0.9 kgs

Model No	Gauge	Crown(A)	Width(B)x Thickness(C)	Length(D)	Capacity	Working Pressure
1013JS	20 GA	11.2 mm	0.6 x 1.2 mm	5~16 mm	100 pcs	70~110 psi
1013FS	23 GA	11.2 mm	0.5 x 0.7 mm	5~16 mm	150 pcs	70~110 psi
A1116S	20 GA	10.8 mm	0.5 x 1.22 mm	5~16 mm	100 pcs	70~110 psi
416JS	20 GA	5.25 mm	0.56 x 1.16 mm	5~16 mm	100 pcs	70~110 psi
7116S	22 GA	9.1 mm	0.6 x 0.75 mm	5~16 mm	150 pcs	70~110 psi
8016FS	22 GA	12.45 mm	0.51 x 0.73 mm	5~16 mm	150 pcs	70~110 psi
SNCA16S	22 GA	4.85 mm	0.6 x 0.74 mm	5~16 mm	150 pcs	70~110 psi
SNCC16S	22 GA	9.1 mm	0.6 x 0.75 mm	5~16 mm	180 pcs	70~110 psi
SNCE16S	20 GA	4.7 mm	0.5 x 1.25 mm	5~16 mm	100 pcs	70~110 psi
SNCG16S	20 GA	9.5 mm	0.6 x 1.3 mm	5~16 mm	100 pcs	70~110 psi
SNCW16S	21 GA	4.8 mm	0.69 x 0.9 mm	5~16 mm	150 pcs	70~110 psi
SJK16S	22 GA	4.1 mm	0.6 x 0.74 mm	5~16 mm	150 pcs	70~110 psi
4016S	21 GA	4.8 mm	0.63 x 0.9 mm	5~16 mm	100 pcs	70~110 psi
9716S	21 GA	4.5 mm	0.65 x 0.95 mm	5~16 mm	100 pcs	70~110 psi
9916S	21 GA	5.4 mm	0.59 x 0.98 mm	5~16 mm	100 pcs	70~110 psi

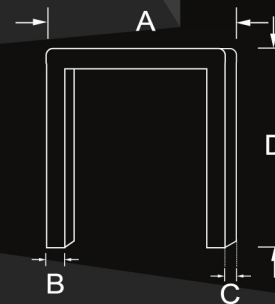

## APPLICATION:





# Rear Exhaust Upholstery Stapler With Auto Firing



L x W x H	216x38x140 mm
Weight	0.9 kgs

Model No	Gauge	Crown(A)	Width(B)x Thickness(C)	Length(D)	Capacity	Working Pressure
1013JA	20 GA	11.2 mm	0.6 x 1.2 mm	5~16 mm	100 pcs	70~110 psi
1013FA	23 GA	11.2 mm	0.5 x 0.7 mm	5~16 mm	150 pcs	70~110 psi
A1116A	20 GA	10.8 mm	0.5 x 1.22 mm	5~16 mm	100 pcs	70~110 psi
1416A	22 GA	10.15 mm	0.58 x 0.74 mm	5~16 mm	180 pcs	70~110 psi
416JA	20 GA	5.25 mm	0.56 x 1.16 mm	5~16 mm	100 pcs	70~110 psi
5016A	20 GA	12.55 mm	0.5 x 1.27 mm	5~16 mm	100 pcs	70~110 psi
6416A	22 GA	12.45 mm	0.51 x 0.73 mm	5~16 mm	150 pcs	70~110 psi
7116A	22 GA	9.1 mm	0.6 x 0.75 mm	5~16 mm	150 pcs	70~110 psi
8016A	21 GA	12.8 mm	0.63 x 0.9 mm	5~16 mm	100 pcs	70~110 psi
8016FA	22 GA	12.45 mm	0.51 x 0.73 mm	5~16 mm	150 pcs	70~110 psi
8416A	21 GA	12.3 mm	0.55 x 1.0 mm	5~16 mm	100 pcs	70~110 psi
SNCA16A	22 GA	4.85 mm	0.6 x 0.74 mm	5~16 mm	150 pcs	70~110 psi
SNCC16A	22 GA	9.1 mm	0.6 x 0.75 mm	5~16 mm	180 pcs	70~110 psi
SNCE16A	20 GA	4.7 mm	0.5 x 1.25 mm	5~16 mm	100 pcs	70~110 psi
SNCF16A	20 GA	12.8 mm	0.5 x 1.25 mm	5~16 mm	100 pcs	70~110 psi
SNCG16A	20 GA	9.5 mm	0.6 x 1.3 mm	5~16 mm	100 pcs	70~110 psi
SNCW16A	21 GA	4.8 mm	0.69 x 0.9 mm	5~16 mm	150 pcs	70~110 psi
SJK16A	22 GA	4.1 mm	0.6 x 0.74 mm	5~16 mm	150 pcs	70~110 psi
4016A	21 GA	4.8 mm	0.63 x 0.9 mm	5~16 mm	100 pcs	70~110 psi
9716A	21 GA	4.5 mm	0.65 x 0.95 mm	5~16 mm	100 pcs	70~110 psi
9916A	21 GA	5.4 mm	0.59 x 0.98 mm	5~16 mm	100 pcs	70~110 psi

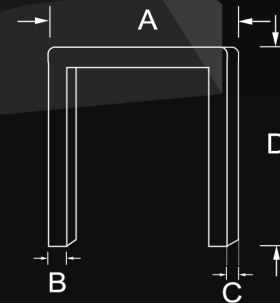

## APPLICATION

- Furniture
- Upholstery
- Automotive vinyl
- Interior
- Trimming
- House decoration
- Carpet edge

## FEATURES

- Adjustable shooting mode (single firing / auto firing)
- Rapid shooting system
- Light weight and compact size
- One hand manual rear latch (easy loading)
- Rear air exhaust and anti dirt on workpiece
- 30~40% lower air consumption than other competitors
- Durable driver unit with POM material

## APPLICATION:



# Rear Exhaust Upholstery Stapler With Single Firing And Long Magazine

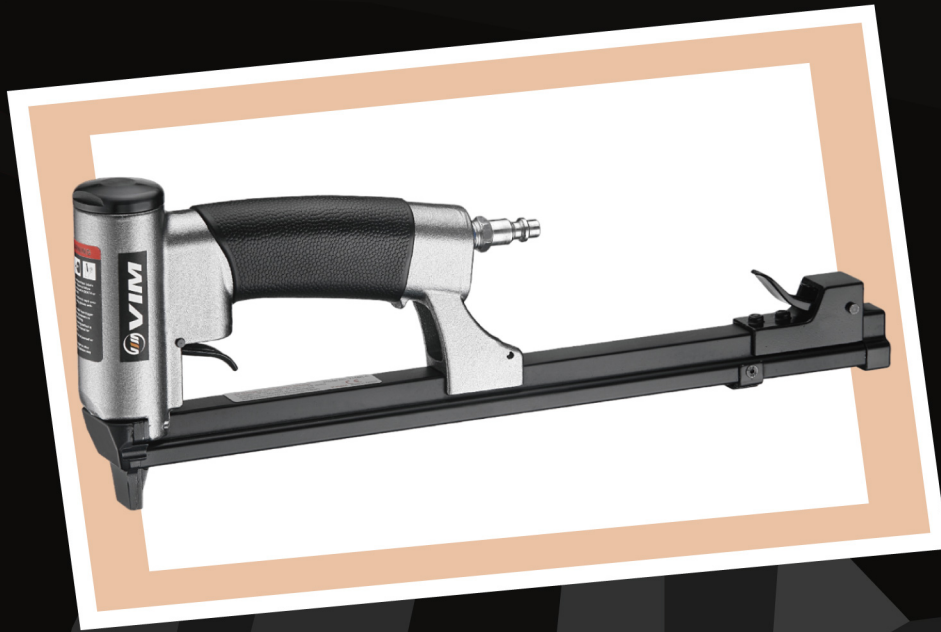

## APPLICATION

- Furniture
- Upholstery
- Automotive vinyl
- Interior
- Trimming
- House decoration
- Carpet edge

## FEATURES

- Compact size
- Powerful
- Light weight
- One hand manual rear latch (easy loading)
- Rear air exhaust and anti dirt on workpiece
- 30~40% lower air consumption than other competitors
- Durable driver unit with POM material

## APPLICATION:



L x W x H	380x38x140 mm
Weight	1.2 kgs

Model No	Gauge	Crown(A)	Width(B)x Thickness(C)	Length(D)	Capacity	Working Pressure
1013JSLM	20 GA	11.2 mm	0.6 x 1.2 mm	5~16 mm	220 pcs	70~110 psi
1013FSLM	23 GA	11.2 mm	0.5 x 0.7 mm	5~16 mm	400 pcs	70~110 psi
A1116SLM	20 GA	10.8 mm	0.5 x 1.22 mm	5~16 mm	220 pcs	70~110 psi
5016SLM	20 GA	12.55 mm	0.5 x 1.27 mm	5~16 mm	220 pcs	70~110 psi
6416SLM	22 GA	12.45 mm	0.51 x 0.73 mm	5~16 mm	400 pcs	70~110 psi
7116SLM	22 GA	9.1 mm	0.6 x 0.75 mm	5~16 mm	400 pcs	70~110 psi
8016SLM	21 GA	12.8 mm	0.63 x 0.9 mm	5~16 mm	270 pcs	70~110 psi
8016FSLM	22 GA	12.45 mm	0.51 x 0.73 mm	5~16 mm	300 pcs	70~110 psi
8416SLM	21 GA	12.3 mm	0.55 x 1 mm	5~16 mm	200 pcs	70~110 psi
SNCC16SLM	22 GA	9.1 mm	0.6 x 0.75 mm	5~16 mm	375 pcs	70~110 psi
SNCF16SLM	20 GA	12.8 mm	0.5 x 1.25 mm	5~16 mm	200 pcs	70~110 psi
SNCG16SLM	20 GA	9.5 mm	0.6 x 1.3 mm	5~16 mm	220 pcs	70~110 psi

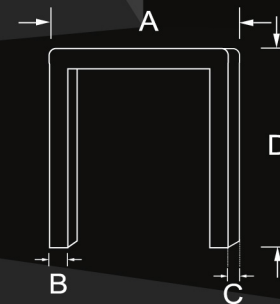



# Rear Exhaust Upholstery Stapler With Auto Firing And Long Magazine

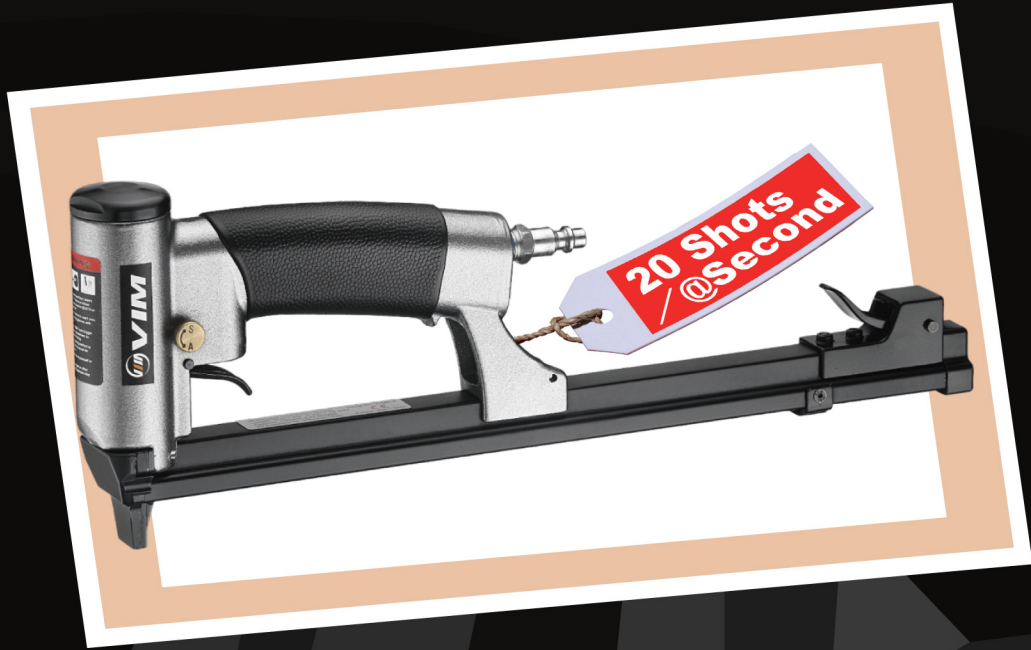

L x W x H	380x38x140 mm
Weight	1.2 kgs

Model No	Gauge	Crown(A)	Width(B)x Thickness(C)	Length(D)	Capacity	Working Pressure
1013JALM	20 GA	11.2 mm	0.6 x 1.2 mm	5~16 mm	220 pcs	70~110 psi
1013FALM	23 GA	11.2 mm	0.5 x 0.7 mm	5~16 mm	400 pcs	70~110 psi
A1116ALM	20 GA	10.8 mm	0.5 x 1.22 mm	5~16 mm	220 pcs	70~110 psi
5016ALM	20 GA	12.55 mm	0.5 x 1.27 mm	5~16 mm	220 pcs	70~110 psi
6416ALM	22 GA	12.45 mm	0.51 x 0.73 mm	5~16 mm	400 pcs	70~110 psi
7116ALM	22 GA	9.1 mm	0.6 x 0.75 mm	5~16 mm	400 pcs	70~110 psi
8016ALM	21 GA	12.8 mm	0.63 x 0.9 mm	5~16 mm	270 pcs	70~110 psi
8016FALM	22 GA	12.45 mm	0.51 x 0.73 mm	5~16 mm	300 pcs	70~110 psi
8416ALM	21 GA	12.3 mm	0.55 x 1 mm	5~16 mm	200 pcs	70~110 psi
SNCC16ALM	22 GA	9.1 mm	0.6 x 0.75 mm	5~16 mm	375 pcs	70~110 psi
SNCF16ALM	20 GA	12.8 mm	0.5 x 1.25 mm	5~16 mm	200 pcs	70~110 psi
SNCG16ALM	20 GA	9.5 mm	0.6 x 1.3 mm	5~16 mm	220 pcs	70~110 psi

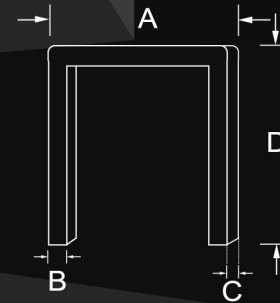

## APPLICATION

- Furniture
- Upholstery
- Automotive vinyl
- Interior
- Trimming
- House decoration
- Carpet edge

## FEATURES

- Adjustable shooting mode (single firing / auto firing)
- Rapid shooting system
- Light weight and compact size
- One hand manual rear latch (easy loading)
- Rear air exhaust and anti dirt on workpiece
- 30~40% lower air consumption than other competitors
- Durable driver unit with POM material

## APPLICATION:



# Rear Exhaust Upholstery Stapler With Single Firing And Long Nose



L x W x H	216x38x197 mm
Weight	0.9 kgs

Model No	Gauge	Crown(A)	Width(B)x Thickness(C)	Length(D)	Capacity	Working Pressure
1013JSLN	20 GA	11.2 mm	0.6 x 1.2 mm	5~16 mm	100 pcs	70~110 psi
1013FSLN	23 GA	11.2 mm	0.5 x 0.7 mm	5~16 mm	150 pcs	70~110 psi
A1116SLN	20 GA	10.8 mm	0.5 x 1.22 mm	5~16 mm	100 pcs	70~110 psi
5016SLN	20 GA	12.55 mm	0.5 x 1.27 mm	5~16 mm	100 pcs	70~110 psi
7116SLN	22 GA	9.1 mm	0.6 x 0.75 mm	5~16 mm	150 pcs	70~110 psi
8016SLN	21 GA	12.8 mm	0.63 x 0.9 mm	5~16 mm	100 pcs	70~110 psi
SNCC16SLN	22 GA	9.1 mm	0.6 x 0.75 mm	5~16 mm	180 pcs	70~110 psi
SNCF16SLN	20 GA	12.8 mm	0.5 x 1.25 mm	5~16 mm	100 pcs	70~110 psi

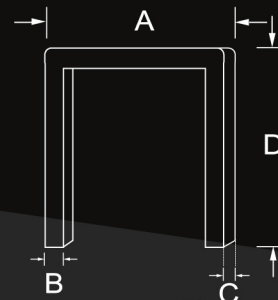

## APPLICATION

- Furniture
- Upholstery
- Automotive vinyl
- Interior
- Trimming
- House decoration
- Carpet edge

## FEATURES

- Compact size
- Powerful
- Light weight
- One hand manual rear latch (easy loading)
- Rear air exhaust and anti dirt on workpiece
- 30~40% lower air consumption than other competitors
- Durable driver unit with POM material

## APPLICATION:





# Rear Exhaust Upholstery Stapler With Auto Firing And Long Nose



L x W x H	216x38x197 mm
Weight	0.9 kgs

Model No	Gauge	Crown(A)	Width(B)x Thickness(C)	Length(D)	Capacity	Working Pressure
1013JALN	20 GA	11.2 mm	0.6 x 1.2 mm	5~16 mm	100 pcs	70~110 psi
1013FALN	23 GA	11.2 mm	0.5 x 0.7 mm	5~16 mm	150 pcs	70~110 psi
A1116ALN	20 GA	10.8 mm	0.5 x 1.22 mm	5~16 mm	100 pcs	70~110 psi
5016ALN	20 GA	12.55 mm	0.5 x 1.27 mm	5~16 mm	100 pcs	70~110 psi
7116ALN	22 GA	9.1 mm	0.6 x 0.75 mm	5~16 mm	150 pcs	70~110 psi
8016ALN	21 GA	12.8 mm	0.63 x 0.9 mm	5~16 mm	100 pcs	70~110 psi
SNCC16ALN	22 GA	9.1 mm	0.6 x 0.75 mm	5~16 mm	180 pcs	70~110 psi
SNCF16ALN	20 GA	12.8 mm	0.5 x 1.25 mm	5~16 mm	100 pcs	70~110 psi

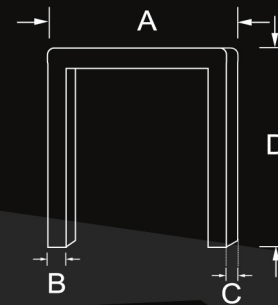

## APPLICATION

- Furniture
- Upholstery
- Automotive vinyl
- Interior
- Trimming
- House decoration
- Carpet edge

## FEATURES

- Adjustable shooting mode (single firing / auto firing)
- Rapid shooting system
- Light weight and compact size
- One hand manual rear latch (easy loading)
- Rear air exhaust and anti dirt on workpiece
- 30~40% lower air consumption than other competitors
- Durable driver unit with POM material

## APPLICATION:



# Rear Exhaust Upholstery Stapler With Single Firing, Long Nose And Long Magazine

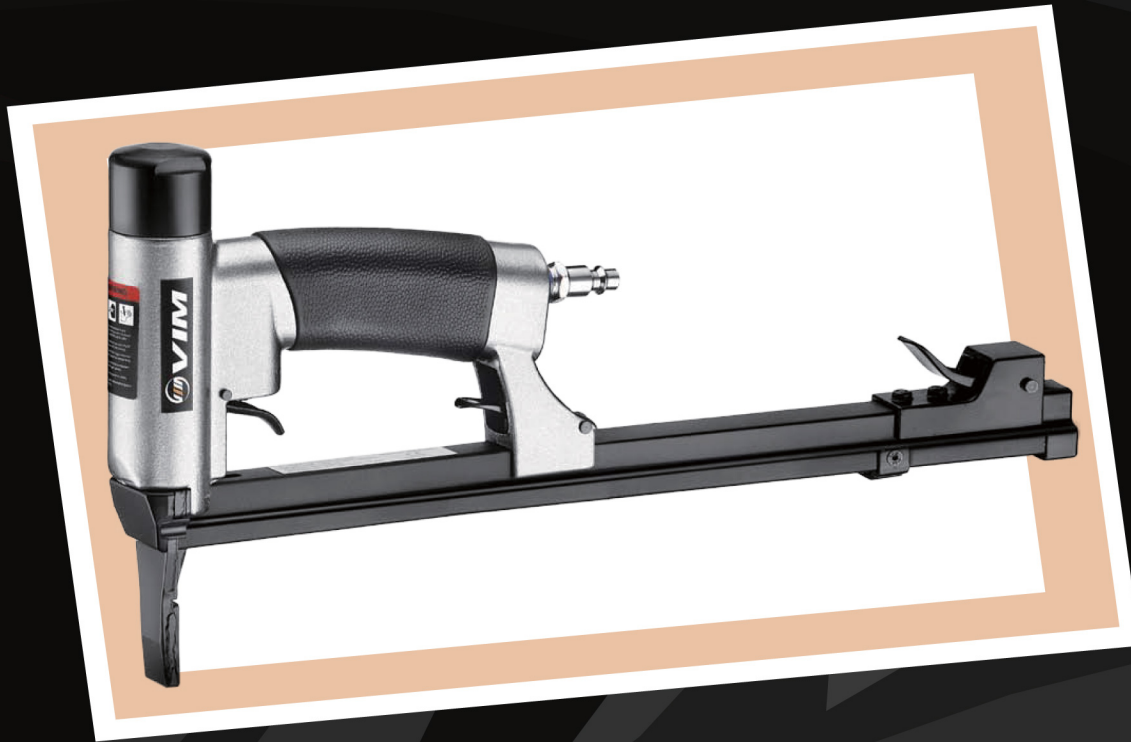

L x W x H	380x38x197 mm
Weight	1.2 kgs

Model No	Gauge	Crown(A)	Width(B)x Thickness(C)	Length(D)	Capacity	Working Pressure
1013JSLNM	20 GA	11.2 mm	0.6 x 1.2 mm	5~16 mm	220 pcs	70~110 psi
1013FSLNM	23 GA	11.2 mm	0.5 x 0.7 mm	5~16 mm	400 pcs	70~110 psi
A1116SLNM	20 GA	10.8 mm	0.5 x 1.22 mm	5~16 mm	220 pcs	70~110 psi
5016SLNM	20 GA	12.55 mm	0.5 x 1.27 mm	5~16 mm	220 pcs	70~110 psi
7116SLNM	22 GA	9.1 mm	0.6 x 0.75 mm	5~16 mm	400 pcs	70~110 psi
8016SLNM	21 GA	12.8 mm	0.63 x 0.9 mm	5~16 mm	270 pcs	70~110 psi
SNCC16SLNM	22 GA	9.1 mm	0.6 x 0.75 mm	5~16 mm	375 pcs	70~110 psi
SNCF16SLNM	20 GA	12.8 mm	0.5 x 1.25 mm	5~16 mm	200 pcs	70~110 psi

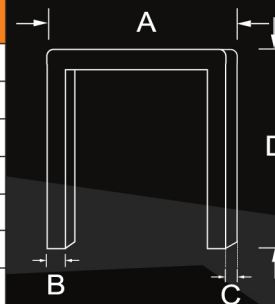

## APPLICATION

- Furniture
- Upholstery
- Automotive vinyl
- Interior
- Trimming
- House decoration
- Carpet edge

## FEATURES

- Compact size
- Powerful
- Light weight
- One hand manual rear latch (easy loading)
- Rear air exhaust and anti dirt on workpiece
- 30~40% lower air consumption than other competitors
- Durable driver unit with POM material

## APPLICATION:





# Rear Exhaust Upholstery Stapler With Auto Firing, Long Nose And Long Magazine

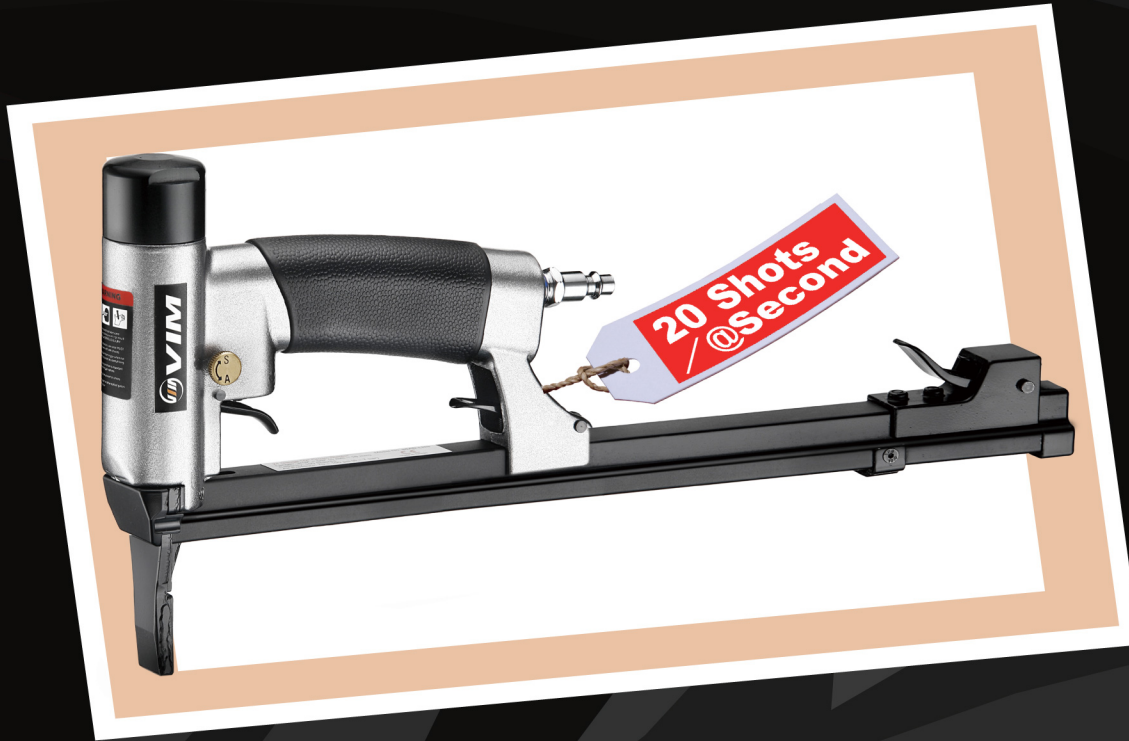

L x W x H	380x38x197 mm
Weight	1.2 kgs

Model No	Gauge	Crown(A)	Width(B)x Thickness(C)	Length(D)	Capacity	Working Pressure
1013JALNM	20 GA	11.2 mm	0.6 x 1.2 mm	5~16 mm	220 pcs	70~110 psi
1013FALNM	23 GA	11.2 mm	0.5 x 0.7 mm	5~16 mm	400 pcs	70~110 psi
A1116ALNM	20 GA	10.8 mm	0.5 x 1.22 mm	5~16 mm	220 pcs	70~110 psi
5016ALNM	20 GA	12.55 mm	0.5 x 1.27 mm	5~16 mm	220 pcs	70~110 psi
7116ALNM	22 GA	9.1 mm	0.6 x 0.75 mm	5~16 mm	400 pcs	70~110 psi
8016ALNM	21 GA	12.8 mm	0.63 x 0.9 mm	5~16 mm	270 pcs	70~110 psi
SNCC16ALNM	22 GA	9.1 mm	0.6 x 0.75 mm	5~16 mm	375 pcs	70~110 psi
SNCF16ALNM	20 GA	12.8 mm	0.5 x 1.25 mm	5~16 mm	200 pcs	70~110 psi

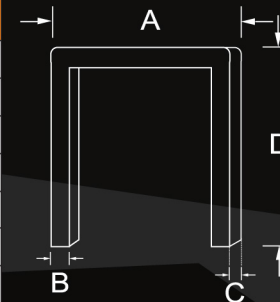

## APPLICATION

- Furniture
- Upholstery
- Automotive vinyl
- Interior
- Trimming
- House decoration
- Carpet edge

## FEATURES

- Adjustable shooting mode (single firing / auto firing)
- Rapid shooting system
- Light weight and compact size
- One hand manual rear latch (easy loading)
- Rear air exhaust and anti dirt on workpiece
- 30~40% lower air consumption than other competitors
- Durable driver unit with POM material

## APPLICATION:



# Rear Exhaust Upholstery Stapler With Single Firing

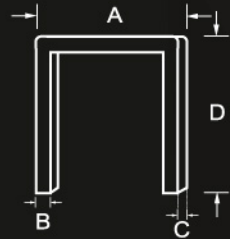

L x W x H	216x43x148 mm
Weight	0.9 kgs
Working Pressure	60~90 psi

Model No	Gauge	Crown(A)	Width(B)x Thickness(C)	Length(D)	Capacity
8016A1	21 GA	12.7 mm	0.65 x 0.95 mm	4~16 mm	145 pcs
7116A1	23 GA	9.5 mm	0.75 x 0.6 mm	4~14 mm	175 pcs
5016A1	20 GA	12.7 mm	0.5 x 1.25 mm	4~16 mm	105 pcs
1416A1	23 GA	9.5 mm	0.55x 0.75 mm	4~16 mm	185 pcs
1013JA1	20 GA	11.2 mm	0.6 x 1.2 mm	6~13 mm	100 pcs
1013FA1	22 GA	11.2 mm	0.5 x 0.7 mm	6~13 mm	100 pcs

## APPLICATION

- Furniture
- Upholstery
- Wooden case
- Decoration

## FEATURES

- Compact and lightweight design prevents arm fatigue of users'
- Trigger lock as a safety precaution while tool is not in use
- Ergonomic comfort handgrip provides a firm grip for user
- Convenient drop-in loading provides quick fastener reloading



# Rear Exhaust Upholstery Stapler With Auto Firing



L x W x H	216x43x148 mm
Weight	0.9 kgs
Working Pressure	60~90 psi

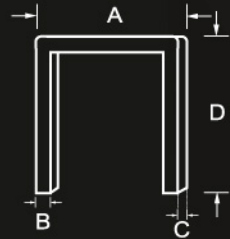

Model No	Gauge	Crown(A)	Width(B)x Thickness(C)	Length(D)	Capacity
8016AW	21 GA	12.7 mm	0.65 x 0.95 mm	4~16 mm	145 pcs
7116AW	23 GA	9.5 mm	0.75 x 0.6 mm	4~14 mm	175 pcs
5016AW	20 GA	12.7 mm	0.5 x 1.25 mm	4~16 mm	105 pcs
1416AW	23 GA	9.5 mm	0.55x 0.75 mm	4~16 mm	185 pcs
1013JAW	20 GA	11.2 mm	0.6 x 1.2 mm	6~13 mm	100 pcs
1013FAW	22 GA	11.2 mm	0.5 x 0.7 mm	6~13 mm	100 pcs

## APPLICATION

- Furniture
- Upholstery
- Wooden case
- Decoration

## FEATURES

- Compact and lightweight design prevents arm fatigue of users'
- Trigger lock as a safety precaution while tool is not in use
- Ergonomic comfort handgrip provides a firm grip for user
- Convenient drop-in loading provides quick fastener reloading

# Rear Exhaust Upholstery Stapler With Long Magazine, Single Firing



L x W x H	350x43x148 mm
Weight	1.1 kgs
Working Pressure	60~90 psi

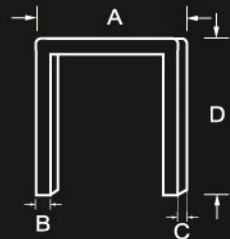

Model No	Gauge	Crown(A)	Width(B)x Thickness(C)	Length(D)	Capacity
8016LM	21 GA	12.7 mm	0.65 x 0.95 mm	4~16 mm	280 pcs
7116LM	23 GA	9.5 mm	0.75 x 0.6 mm	4~14 mm	360 pcs
5016LM	20 GA	12.7 mm	0.5 x 1.25 mm	4~16 mm	210 pcs
1416LM	23 GA	9.5 mm	0.55 x 0.75 mm	4~16 mm	340 pcs
1013JLM	20 GA	11.2 mm	0.6 x 1.2 mm	6~13 mm	200 pcs
1013FLM	22 GA	11.2 mm	0.5 x 0.7 mm	6~13 mm	200 pcs

## APPLICATION

- Furniture
- Upholstery
- Wooden case
- Decoration

## FEATURES

- Compact and lightweight design prevents arm fatigue of users'
- Trigger lock as a safety precaution while tool is not in use
- Ergonomic comfort handgrip provides a firm grip for user
- Convenient drop-in loading provides quick fastener reloading



# Rear Exhaust Upholstery Stapler With Long Magazine, Auto Firing

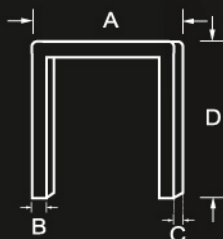

L x W x H	350x43x148 mm
Weight	1.1 kgs
Working Pressure	60~90 psi

Model No	Gauge	Crown(A)	Width(B)x Thickness(C)	Length(D)	Capacity
8016LMA	21 GA	12.7 mm	0.65 x 0.95 mm	4~16 mm	280 pcs
7116LMA	23 GA	9.5 mm	0.75 x 0.6 mm	4~14 mm	360 pcs
5016LMA	20 GA	12.7 mm	0.5 x 1.25 mm	4~16 mm	210 pcs
1416LMA	23 GA	9.5 mm	0.55 x 0.75 mm	4~16 mm	340 pcs
1013JLMA	20 GA	11.2 mm	0.6 x 1.2 mm	6~13 mm	200 pcs
1013FLMA	22 GA	11.2 mm	0.5 x 0.7 mm	6~13 mm	200 pcs

## APPLICATION

- Furniture
- Upholstery
- Wooden case
- Decoration

## FEATURES

- Compact and lightweight design prevents arm fatigue of users'
- Trigger lock as a safety precaution while tool is not in use
- Ergonomic comfort handgrip provides a firm grip for user
- Convenient drop-in loading provides quick fastener reloading

# Rear Exhaust Upholstery Stapler With Long Nose, Single Firing

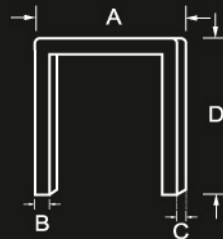

L x W x H	216x43x198 mm
Weight	1 kgs
Working Pressure	60~90 psi

Model No	Gauge	Crown(A)	Width(B)x Thickness(C)	Length(D)	Capacity
8016LN	21 GA	12.7 mm	0.65 x 0.95 mm	4~16 mm	145 pcs
7116LN	23 GA	9.5 mm	0.75 x 0.6 mm	4~14 mm	175 pcs

## APPLICATION

- Furniture
- Upholstery
- Wooden case
- Decoration

## FEATURES

- Compact and lightweight design prevents arm fatigue of users'
- Trigger lock as a safety precaution while tool is not in use
- Ergonomic comfort handgrip provides a firm grip for user
- Convenient drop-in loading provides quick fastener reloading
- Long nose for easy and precise staple placement

# Rear Exhaust Upholstery Stapler With Long Nose, Auto Firing



L x W x H	216x43x198 mm
Weight	1 kgs
Working Pressure	60~90 psi

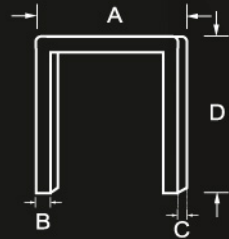

Model No	Gauge	Crown(A)	Width(B)x Thickness(C)	Length(D)	Capacity
8016LNA	21 GA	12.7 mm	0.65 x 0.95 mm	4~16 mm	145 pcs
7116LNA	23 GA	9.5 mm	0.75 x 0.6 mm	4~14 mm	175 pcs
5016LNA	20 GA	12.7 mm	0.5 x 1.25 mm	4~16 mm	105 pcs
1416LNA	23 GA	9.5 mm	0.55 x 0.75 mm	4~16 mm	185 pcs
1013JLNA	20 GA	11.2 mm	0.6 x 1.2 mm	6~13 mm	100 pcs
1013FLNA	22 GA	11.2 mm	0.5 x 0.7 mm	6~13 mm	100 pcs

## APPLICATION

- Furniture
- Upholstery
- Wooden case
- Decoration

## FEATURES

- Compact and lightweight design prevents arm fatigue of users'
- Trigger lock as a safety precaution while tool is not in use
- Ergonomic comfort handgrip provides a firm grip for user
- Convenient drop-in loading provides quick fastener reloading



# Medium Wire Staplers

Model No: 9025C, 9725C, 9225C, SM25C, 4025C, 425JA, 1025JA

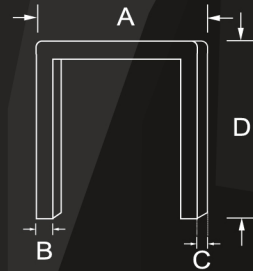

L x W x H	250x58x185 mm
Weight	1.21 kgs

Model No	Crown(A)	Width(B)xThickness(C)	Gauge	Length(D)	Capacity
9025C	5.7 mm	1.25x1.05 mm	18 GA.	10~25 mm	100 pcs
9725C	4.5 mm	0.95x0.70 mm	21 GA.	10~25 mm	100 pcs
9225C	8.7 mm	1.25x1.00 mm	18 GA.	10~25 mm	100 pcs
SM25C	10.0 mm	1.10x1.25 mm	18 GA.	10~25 mm	100 pcs
4025C	5.0 mm	0.90x0.80 mm	21 GA.	10~25 mm	100 pcs
425JA	4.0 mm	1.20x0.60 mm	20 GA.	10~25 mm	100 pcs
1025JA	10.0 mm	1.20x0.60 mm	20 GA.	10~25 mm	100 pcs

## APPLICATION

- Framing, joiner
- Upholstery, furniture, bedding
- Door, window, trimming, picture frames, building components
- Cabinets, furniture, light wood assembly
- Siding, sheathing, paneling, fencing
- Industrial, Pre-Fabricated housing

## FEATURES

- 360 rotatable air deflector
- Bottom load, durable aluminum magazine
- Comfortable rubber grip
- Bump fire trigger
- Sequential trigger valve available
- Belt hook available

# Medium Wire Staplers

Model No: 9040A1



Model No	9040A1
L x W x H	254x58x235 mm
Weight	1.20 kgs
Gauge	18 GA.
Crown(A)	5.8 mm
Width(B)xThickness(C)	1.25x1.00 mm
Length(D)	13~40 mm
Operating Pressure	70~100 psi
Capacity	150 pcs

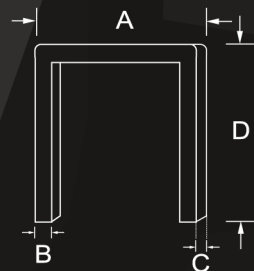

## APPLICATION

- Furniture manufacturing
- Prefabricated( ex: garden, furniture)
- Kitchen and shop racks
- Doors and windows
- Packaging (ex: boxes, matchboarding)

## FEATURES

- Powerful motor allows penetration through hard materials
- Lightweight die cast body prevents arm fatigue during prolong use
- Convenient depth of drive dial allows precise staple settings
- Up-loading design for quick fastener reloading
- Adjustable safety
- Quick release nose cover provides easy access for clearing jams
- Ergonomic comfort handgrip provides a firm grip for user
- High fastener capacity reduces frequency for reloading
- Durable driver and o-ring assembly

# Medium Wire Staplers with Adjustable Safety

Model No: 9040A2, 9240A2



L x W x H	206x58x204 mm
Weight	1.20 kgs
Loading Capacity	150 pcs

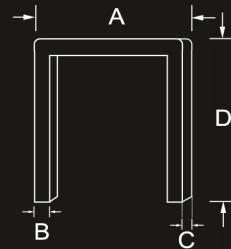

Model No	Gauge	Crown(A)	Width(B)xThickness(C)	Length(D)	Operating Pressure
9040A2	18 GA	5.8 mm	1.25x1.00 mm	13~40 mm	80~110 psi
9240A2	18 GA	8.7 mm	1.25x1.00 mm	13~40 mm	80~110 psi

## APPLICATION

- Furniture manufacturing
- Pre-fabricated housing
- Light wood assembly
- Doors and windows
- Packaging (ex: boxes, matchboarding)

## FEATURES

- Powerful motor allows penetration through hard materials
- Lightweight die cast body prevents arm fatigue during prolong use
- Convenient depth of drive dial allows precise staple settings
- Adjustable safety
- Quick release nose cover provides easy access for clearing jams
- Ergonomic comfort handgrip provides a firm grip for user
- High fastener capacity reduces frequency for reloading
- Durable driver and o-ring assembly



# Heavy Duty Staplers

Model No: 9240SLOC



Model No	9240SLOC
L x W x H	265x59x245 mm
Weight	1.5 kgs
Gauge	18 GA.
Crown(A)	8.7 mm
Width(B)xThickness(C)	1.25x1.00 mm
Length(D)	19~40 mm
Capacity	100 pcs



Bostitch type



BeA type

## APPLICATION

- Drawer assembly
- Cabinet
- Casebacks
- Picture frames
- Crafts
- Bed frames

## FEATURES

- 360° adjustable exhaust port
- Comfortable handle with rubber
- Strong and light weight die cast housing
- Fast and easy bottom loading.
- Adjustable driver length

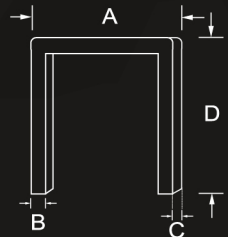

# Wide Crown Staplers

Model No: 16951,16851



L x W x H	365x95x310 mm
Weight	2.88 kgs
Loading Capacity	140 pcs

Model No	Gauge	Crown(A)	Width(B)xThickness(C)	Length(D)
16951	16 GA	12.4 mm	1.65 x 1.40 mm	25-50 mm
16851	16 GA	11.1 mm	1.60 x 1.40 mm	25-50 mm

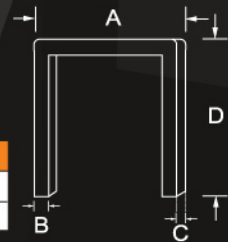

## APPLICATION

- Roofing, framing, packaging
- Door, window, trimming
- Pre-fabricated housing, carpenter, joiner
- Picture frames, pallets, crating
- Industrial, building components

## FEATURES

- Patented quick release nose cover
- 360° adjustable air deflector
- Heavy duty, well balanced
- Sequential fire trigger available

# Wide Crown Staplers

Model No: 16964,16864,16764,1664Q



L x W x H	380x95x310 mm
Weight	2.76 kgs
Loading Capacity	140 pcs

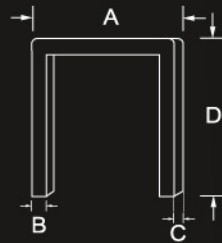

Model No	Gauge	Crown(A)	Width(B)xThickness(C)	Length(D)
16964	16 GA	12.4 mm	1.65 x 1.40 mm	25-64 mm
16864	16 GA	11.1 mm	1.60 x 1.40 mm	25-64 mm
16764	16 GA	11.5 mm	1.60 x 1.40 mm	25-64 mm
1664Q	16 GA	11.3 mm	1.90 x 1.70 mm	25-64 mm

## APPLICATION

- Roofing, carpentry
- Framing, joiner
- Door, window, trimming, picture frames, building components
- Packaging, crating, pallets
- Industrial, pre-fabricated house

## FEATURES

- Patented quick release nose cover
- 360° adjustable air deflector
- Heavy duty, well balanced
- Sequential fire trigger available



# Roofing Stapler

Model No: 1638R



Model No	1638R
L x W x H	330x80x265 mm
Weight	2.42 kgs
Gauge	16 GA
Crown(A)	26.5 mm
Width(B)xThickness(C)	1.6x1.4 mm
Length(D)	12~38 mm
Capacity	140 pcs

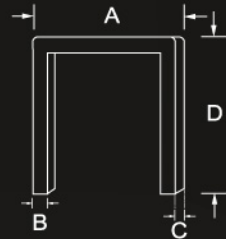

## APPLICATION

- Roofing, framing, packaging
- Door, window, trimming
- Pre-fabricated housing, carpenter, joiner
- Picture frames, pallets, crating
- Industrial, building components

## FEATURES

- Patented quick release nose cover
- 360° adjustable air deflector
- Heavy duty, well balanced
- Sequential fire trigger available