

16° Wire Collated Coil Nailer

Model No: CN55M

■ All parts compatible with MAX®CN55



WARNING

- 1 Read and understand tool safety and caution. Failure to follow warnings could result in death or serious injury.
- 2 Operators and others in work area MUST wear safety.
- 3 Keep fingers AWAY from trigger when not using. Retainers for avoid accidental firing.
- 4 Choice of triggering method is important. Check manual for finger options.
- 5 NEVER point tool at yourself or other in work area.
- 6 NEVER use oxygen or other oxidized gas. Explosions may occur.

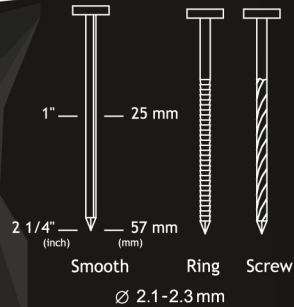

Model No	CN55M
L x W x H	270x131x283 mm
Weight	2.5 kgs
Angle	16°
Fastener Range	25~57 mm
Shank Type	Smooth / Ring / Screw
Capacity	300~400 pcs
Working Pressure	70~100 psi

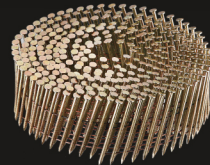

APPLICATION

- Making and repairing pallets
- Crating
- Fencing
- Siding
- Decking
- Sheathing

FEATURES

- Extra heavy-duty; die casting aluminium construction
- Light weight and powerful
- Rugged magazine
- Drives 300-400 nails continuously by full-loading
- Multi-directional exhaust
- Comfortable rubber grip
- Equipped with dust cover and body protector

16° Wire Collated Coil Nailer

Model No: CN60A1

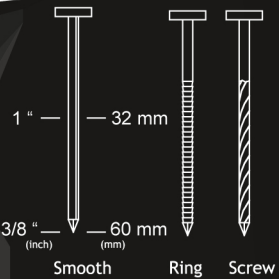

Model No	CN60A1
L x W x H	270x130x270 mm
Weight	2.54 kgs
Angle	16°
Nail Shank Dia.	2.1~2.5 mm
Fastener Range	32~60 mm
Shank Type	Smooth / Ring / Screw
Capacity	350 pcs
Working Pressure	100~120 psi

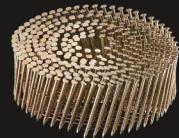

APPLICATION

- Making and repairing pallets
- Crating
- Fencing
- Siding
- Decking
- Sheathing
- Wooden cases, wooden furniture
- Light pallets, wooden sashes

FEATURES

- Extra heavy-duty, die casting aluminium construction
- 360 exhaust deflector allows exhaust of air in any direction
- Rugged magazine
- Drives 350 nails continuously by full-loading
- Depth of drive adjustment to countersink or flush drive nails
- Comfortable rubber grip
- Powerful enough to provide penetration through the toughest material
- Light but powerful

Construction Coil Nailer

Model No: CN65WPA, CN65WPB



Model No	CN65WPA	CN65WPB
L x W x H	300x135x320 mm	
Weight	2.74 kgs	
Angle	15°	
Head Dia.	5.0~6.0 mm	6.0~7.0 mm
Nail Shank Dia.	2.1~2.5 mm	2.5~2.9 mm
Fastener Range	32~65 mm	
Shank Type	Smooth / Ring / Screw	
Capacity	300 pcs	
Working Pressure	75~100 psi	

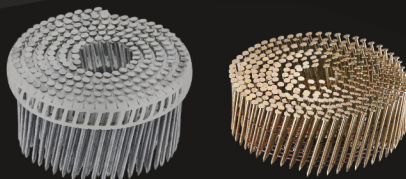
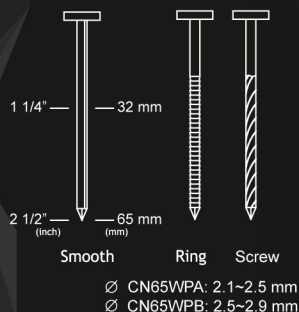

APPLICATION

- Construction work (ex: siding, roofing and sheathing)
- Use for wooden cases
- Light pallets
- Wooden furniture
- Wooden sashes and other wood products

FEATURES

- 360 degree exhaust deflector allows exhaust of air in any direction
- Depth of drive adjustment to countersink or flush drive nails
- Lightweight design prevents arm fatigue for users
- Drives wire and plastic sheet collated nails

16° Wire Collated Coil Nailer

Model No: CN70M

■ All parts compatible with MAX®CN70



Model No	CN70M
L x W x H	306x128x315 mm
Weight	3.5 kgs
Angle	16°
Fastener Range	45~70 mm
Shank Type	Smooth / Ring / Screw
Capacity	225~300 pcs
Operating Pressure	70~100 psi

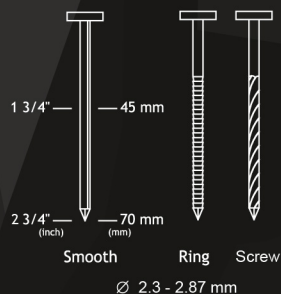

APPLICATION

- Making and repairing pallets
- Crating
- Fencing
- Siding
- Decking
- Sheathing

FEATURES

- Extra heavy-duty: die casting aluminium construction
- Light weight and powerful
- Rugged magazine
- Drives 225~300 nails continuously by full-loading
- Multi-directional exhaust
- Comfortable rubber grip
- Equipped with dust cover and body protector

16° Wire Collated Coil Nailer

Model No: CN80M

■ All parts compatible with MAX®CN80



Model No	CN80M
L x W x H	307x132x362 mm
Weight	3.7 kgs
Angle	16°
Fastener Range	50~83 mm
Shank Type	Smooth / Ring / Screw
Capacity	300 pcs
Operating Pressure	85~120 psi

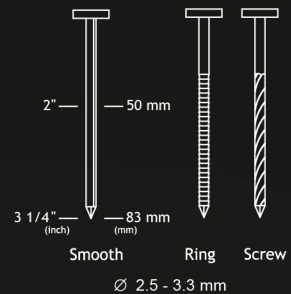

APPLICATION

- Making and repairing pallets
- Crating
- Fencing
- Siding
- Decking
- Sheathing

FEATURES

- Extra heavy-duty; die casting aluminium construction
- Light weight and powerful
- Rugged magazine
- Drives 300 nails continuously by full-loading
- Multi-directional exhaust
- Comfortable rubber grip
- Equipped with dust cover and body protector

15° Wire Collated Coil Nailer

Model No: CN90C



Model No	CN90C
L x W x H	300x130x380 mm
Weight	3.7 kgs
Angle	15°
Fastener Range	50~90 mm
Shank Type	Smooth / Ring / Screw
Capacity	225~300 pcs
Working Pressure	100~200 psi

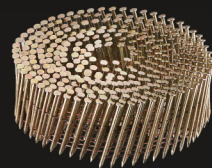
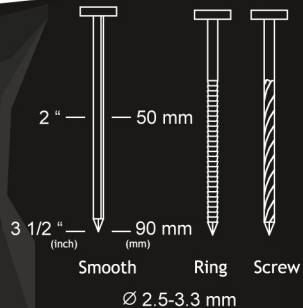

APPLICATION

- Making and repairing pallets
- Crating
- Fencing
- Siding
- Decking
- Sheathing
- Wooden cases, wooden furniture
- Light pallets, wooden sashes

FEATURES

- Extra heavy-duty: die casting aluminium construction
- Light weight and powerful
- Rugged magazine
- Drives 225-300 nails continuously by full-loading
- Multi-directional exhaust
- Comfortable rubber grip
- Powerful enough to provide penetration through the toughest material
- Durable driver and piston o-ring assembly
- Adjustable exhaust cover and safety

16° Wire Collated Coil Nailer

Model No: CN100WPB



Model No	CN130WPB
L x W x H	380x113x420 mm
Weight	5 kgs
Angle	15°
Head Dia.	7.2~8.0 mm
Nail Shank Dia.	3.3~3.8 mm
Fastener Range	50~100 mm
Shank Type	Smooth / Ring / Screw
Capacity	200~300 pcs
Working Pressure	100~120 psi

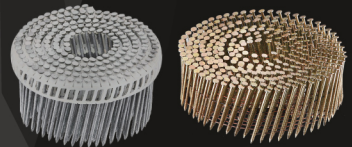
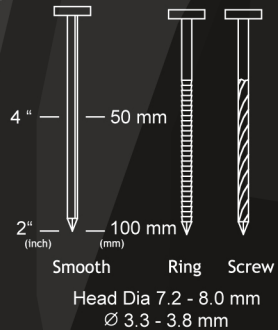

APPLICATION

- Making and repairing pallets
- Crating
- Fencing
- Siding
- Decking
- Sheathing
- Wooden cases, wooden furniture
- Light pallets, wooden sashes

FEATURES

- Extra heavy-duty; die casting aluminium construction
- 360 exhaust deflector allows exhaust of air in any direction
- Rugged magazine
- Drives 200-300 nails continuously by full-loading
- Depth of drive adjustment to countersink or flush drive nails
- Comfortable rubber grip
- Powerful enough to provide penetration through the toughest material
- Light but powerful
- Drives wire and plastic sheet collated nails

16° Wire Collated Coil Nailer

Model No: CN130WPB



Model No	CN130WPB
L x W x H	380x113x480 mm
Weight	5.5 kgs
Angle	15°
Head Dia.	7.2~8.0 mm
Nail Shank Dia.	3.3~3.8 mm
Fastener Range	83~130 mm
Shank Type	Smooth / Ring / Screw
Capacity	200~300 pcs
Working Pressure	100~120 psi

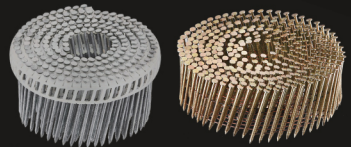
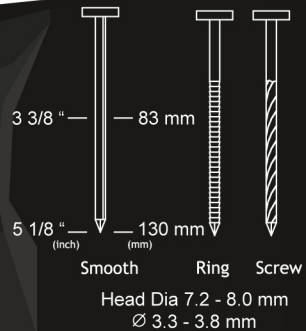

APPLICATION

- Making and repairing pallets
- Crating
- Fencing
- Siding
- Decking
- Sheathing
- Wooden cases, wooden furniture
- Light pallets, wooden sashes

FEATURES

- Extra heavy-duty, die casting aluminium construction
- 360 exhaust deflector allows exhaust of air in any direction
- Rugged magazine
- Drives 200-300 nails continuously by full-loading
- Depth of drive adjustment to countersink or flush drive nails
- Comfortable rubber grip
- Powerful enough to provide penetration through the toughest material
- Light but powerful
- Drives wire and plastic sheet collated nails

Multi-Construction Nailer

Model No: DN42



Single or bump fire



Tool-free depth control



Accurate nailing device for driving nails into material straightly

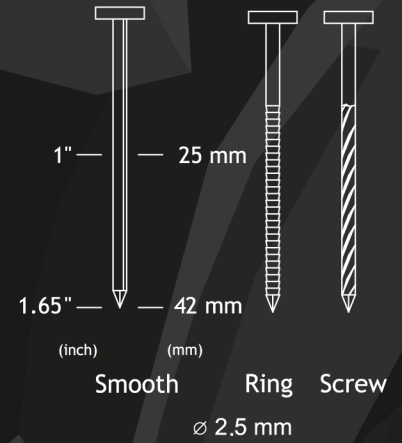

Suitable for all types of metal connectors

Model No	DN42
L x W x H	205x103x203 mm
Weight	1.4 kgs
Max Head Dia	6.8 mm
Shank Dia	2.5 mm
Nail Length	25~42 mm
Capacity	200 nails
Operating Pressure	90~110 psi

APPLICATION

- Drywall installation
- Roof and wall claddings of aluminium, stainless steel or titanium zinc
- Valley boards and metal sheet fixing on wood
- Ideal for slate cladding
- Metal connectors

FEATURES

- Single or bump fire
- Adjustable exhaust cover
- Straight drive nail holders in nose ensure nails will be driven straight
- Light weight
- Adjustable safety
- Dial adjustable depth control
- Special nose with no-mar tip
- 360 degree adjustable exhaust
- Exhaust silencer
- Ergonomic, rubbered handle grip

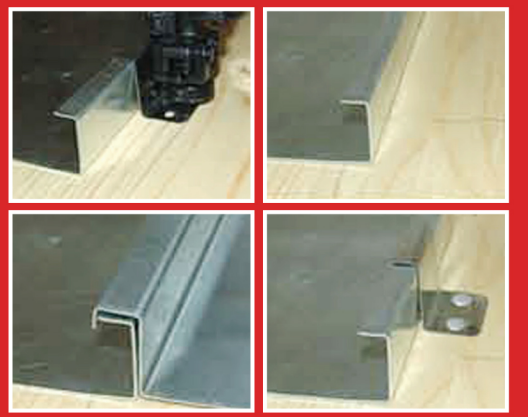

Roofing Nailer

Model No: RN45

■ All parts compatible with Hitachi® NV45AB



Model No	RN45
L x W x H	260x110x260 mm
Weight	2.4 kgs
Nail shank dia	3.05 mm
Length	22~45 mm
Capacity	120 pcs
Working Pressure	90~110 psi

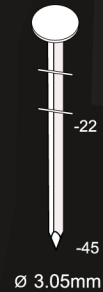

APPLICATION

- Roofing
- Insulate sheathing and siding

FEATURES

- Accepts all 3.05 mm diameter 15 degree coil roofing nails
- Adjustable shingle guide for optimal performance
- Durable steel safety foot with carbide inserts
- Lightweight design for improved maneuverability
- Ergonomic comfort handgrip provides a firm grip for user
- Durable driver and o-ring assembly

12 GA. 0° Heavy Duty Concrete Nailer

Model No: C3040W



Model No	C3040W
L x W x H	302x90x305 mm
Weight	3.0 kgs
Gauge	12 GA
Shank Dia	2.6~3.0 mm
Fastener Range	15~40 mm
Capacity	30 pcs
Working Pressure	80~120 psi

APPLICATION

- Reinforce construction
- Tectonic floor
- Drywall and partition
- Steel to concrete
- Steel to steel
- Wood to concrete

FEATURES

- More powerful than gas concrete pinner
- Use same pins with gas nailer
- 360 degrees exhaust deflector
- Adjustable safety for pin depth control
- Extra handle bar for easy operation
- Single and consecutive fire

Stepped Shank

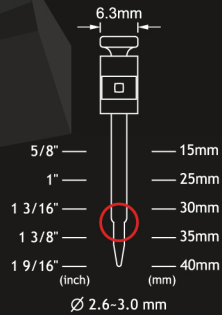

Ballistic Shank

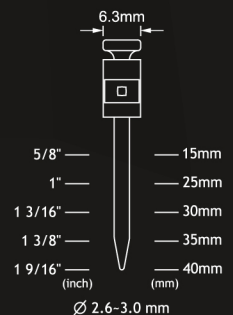

12 GA. 0° Heavy Duty Concrete Nailer

Model No: C3065W



Model No	C3065W
L x W x H	400x113x430 mm
Weight	3.0 kgs
Gauge	12 GA
Shank Dia	2.6~3.0 mm
Fastener Range	15~65 mm
Capacity	42 pcs
Working Pressure	80~120 psi

APPLICATION

- Reinforce construction
- Tectonic floor
- Drywall and partition
- Steel to concrete
- Steel to steel
- Wood to concrete

FEATURES

- More powerful than gas concrete pinner
- Use same pins with gas nailer
- 360 degrees exhaust deflector
- Adjustable safety for pin depth control
- Extra handle bar for easy operation
- Single and consecutive fire

Stepped Shank

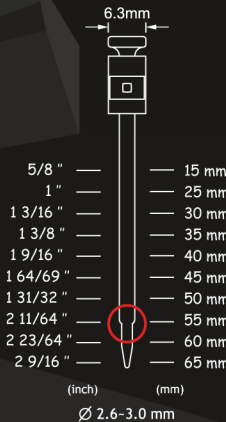

Ballistic Shank

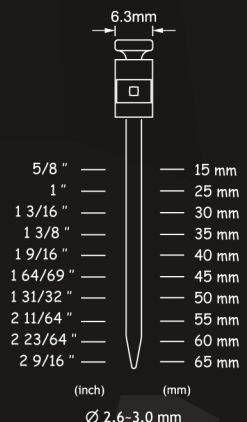

Corrugated Nailers

Model No: CF175P, CF185S, CF254S, CF264P

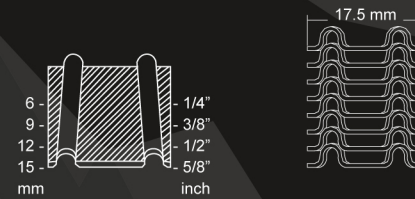

CF175P

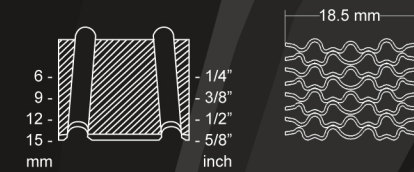

CF185S

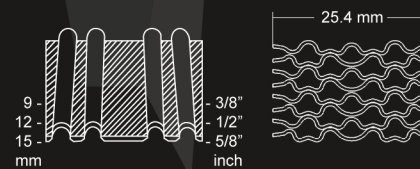

CF254S

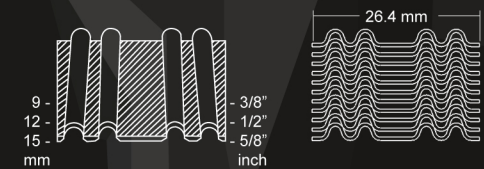

CF264P

Model No	CF175P	CF185S	CF254S	CF264P
L x W x H	305x92x270 mm		300x92x270 mm	
Weight	2.3 kgs		2.4 kgs	
Crown	17.5 mm	18.5 mm	25.4 mm	26.4 mm
Length Of Fastener	6, 9, 12, 15 mm		9, 12, 15 mm	
Capacity	180 pcs	80 pcs	80 pcs	180 pcs
Operating Pressure	100~120 psi			

APPLICATION

- Furniture, bedding
- Ticking (flange) to Innerspring
- Novelty
- Components

FEATURES

- Adjustable driver length
- Magnesium housing
- Extremely light for using

Corrugated Nailer

Model No: WN3525

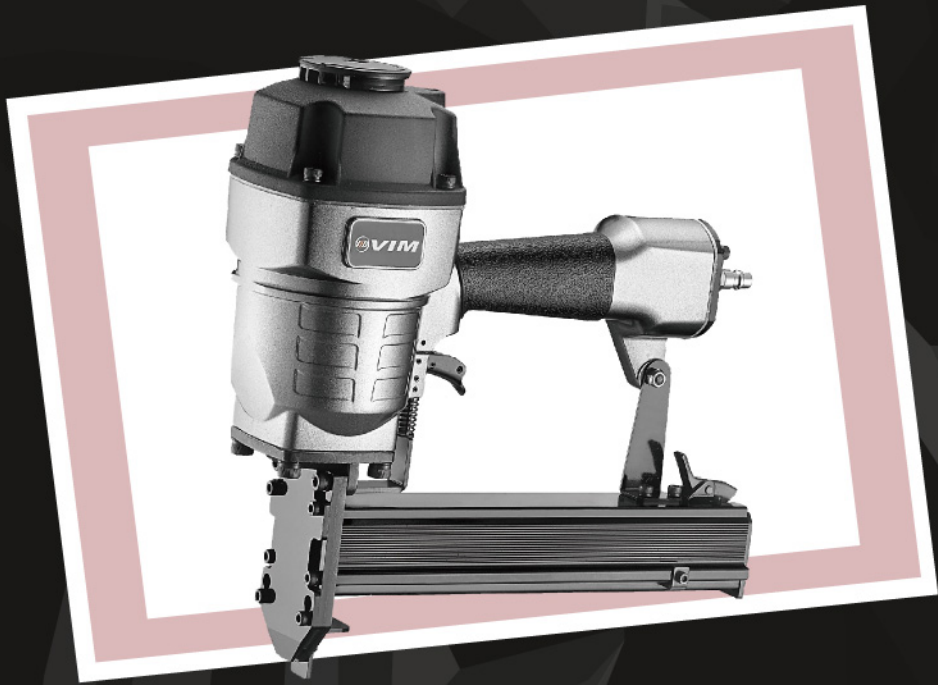

Model No	WN3525
L x W x H	350x110x340 mm
Weight	4.0 kgs
Crown	35 mm
Fastener Range	12, 15, 18, 25 mm
Loading Capacity	100 pcs
Working Pressure	100~120 psi

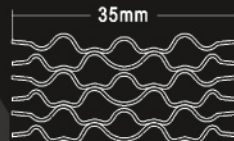

APPLICATION

- Picture frames
- Mirror frames
- Door frames
- Window frame

FEATURES

- Perfect balance and lightweight
- Powerful for hard wood applications
- 360° adjustable exhaust cover
- Slide-in insert to adjust the different lengths of fasteners
- Fasteners for WN3525 equivalent to fasteners for BeA®
- Anti-double shot mechanism
- Profiled nose and extended driver to work on corner joints
- Aluminium alloy housing

Finishing Nailer

Model No: DA50S



Model No	DA50S
L x W x H	320x108x290 mm
Weight	2.0 kgs
Nail Shank Dia	1.8 mm
Length	25~50 mm
Nail Angle	34°
Capacity	100 pcs
Operating Pressure	70~110 psi
Collated Type	Paper

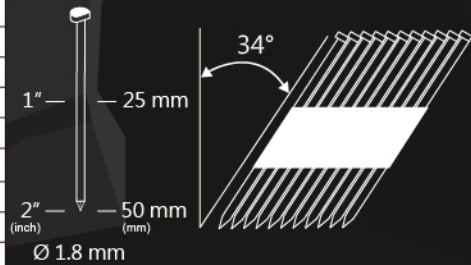

APPLICATION

- Interior finish and trim
- Exterior finish and trim
- Furniture
- Cabinet work
- Staircases
- Crown moulding, architrave, skirtings, door frames
- Window casings, dados, exterior finish trim, decorative trim
- Cabinet face frames and door/window casing

FEATURES

- 360-degree adjustable exhaust port
- Light weight die-cast housing
- Quick release for fast clearing for jam
- Fast rear loading
- No mar rubber tip
- Adjustable depth control

Finishing Nailer

Model No: DA64S



Model No	DA64S
L x W x H	300x92x310 mm
Weight	2.29 kgs
Nail Shank Dia	1.8 mm
Length	32~64 mm
Nail Angle	34°
Capacity	100 pcs
Operating Pressure	70~110 psi
Collated Type	Paper

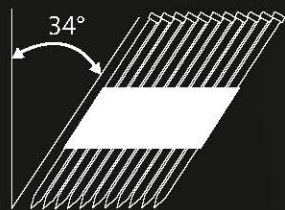

APPLICATION

- Interior finish and trim
- Exterior finish and trim
- Furniture
- Cabinet work
- Staircases

FEATURES

- 360-degree adjustable exhaust port
- Light weight magnesium housing
- Quick release for fast clearing for jam
- Fast rear loading
- No mar rubber tip
- Adjustable depth control

15 & 16 GA. 2 in 1 Light-Duty Concrete Finishing Nailer Model No: T50L



Model No	T50L	
L x W x H	250x58x248 mm	
Weight	1.37 kgs	
Gauge	15 GA.	16 GA.
Nail shank	1.83 mm	1.6x1.4 mm
Length	15, 20, 25, 30, 32, 35, 38, 40, 45, 50 mm	
Capacity	100 pcs	

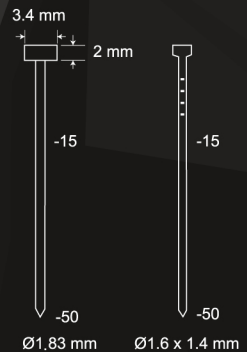

APPLICATION

- Upholstery, furniture, bedding
- Door, window, trimming, picture frames
- Building components
- Cabinets, furniture, light wood assembly
- Siding, sheathing, paneling, fencing

FEATURES

- Accepts both 16 GA. finish nails and 0.072" (1.83 mm) concrete nails
- 360° adjustable air deflector
- Light weight
- Well balanced
- Holds 2 strips of 16 GA. finish nails

15 & 16 GA. 2 in 1 Heavy-Duty Concrete / Finishing Nailer Model No: T50H



Model No	T50HA	
L x W x H	281x72x272 mm	
Weight	2.15 kgs	
Gauge	15 GA.	16 GA.
Nail shank	1.83 mm	1.6 x 1.4 mm
Length	15, 20, 25, 30, 35 38, 40, 45, 50 mm	
Capacity	100 pcs	



APPLICATION

- Door, window, trimming, picture frames
- Building components
- Siding, sheathing, paneling, fencing

FEATURES

- Accepts both 16 GA. finish nails and 0.072" (1.83 mm) concrete nails
- 360° adjustable air deflector
- Bolted release nose cover
- Well balanced - powerful motor
- No mar rubber pad

Finishing Nailer

Model No: T1664



Model No	T1664
L x W x H	317x72x265 mm
Weight	1.91 kgs
Gauge	16 GA.
Nail shank	1.6x1.4 mm
Length	18, 20, 25, 30, 32, 38, 40, 45, 50, 57, 64 mm
Capacity	100 pcs



APPLICATION

- Upholstery, furniture, bedding
- Door, window, trimming, picture frames,
- Building components
- Cabinets, furniture, light wood assembly
- Siding, sheathing, paneling, fencing

FEATURES

- 360° adjustable air deflector
- Quick release nose cover
- Well balanced

18 GA. Finishing Nailer

Model No: F1850



Model No	F1850
L x W x H	250x58x248 mm
Weight	1.37 kgs
Nail Shank	1.26x1.05 mm
Length	15~50 mm
Gauge	18 GA
Capacity	100 pcs
Operating Pressure	70~100 psi

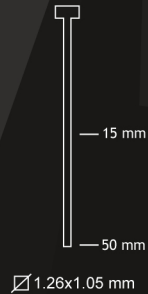

APPLICATION

- Upholstery, furniture, bedding
- Framing, joiner
- Cabinets, furniture, light wood assembly
- Siding, sheathing, paneling, fencing
- Industrial, pre-fabricated housing

FEATURES

- 360° Adjustable air deflector
- Quick release nose cover
- Optional single-bump fire switch available

T-Nailer

Model No: 2264T



Model No	2264T
L x W x H	310x95x310 mm
Weight	2.80 kgs
Nail Shank Dia	2.2~2.5 mm
Length	18,25,32,38,45,50,57,64 mm
Capacity	80 pcs

APPLICATION

- Roofing, carpentry
- Framing, joiner
- Door, window, trimming, picture frames, building components
- Cabinets, furniture, light wood assembly
- Packaging, crating, pallets
- Industrial, pre-fabricated housing

FEATURES

- Accept both .086 & 0.98" / 2.2 & 2.5 mm concrete nails
- 360° Adjustable air deflector
- Powerful
- Well balanced
- Quick release bolted nose
- Sequential trigger mode, can be adjusted to bump fire mode without changing par

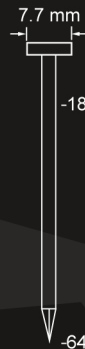

Positive Placement Metal Connector Nailer

Model No: PM3164, PM3160



L x W x H	330x100x315 mm
Weight	2.3 kgs
Nail Capacity	25 nails
Operating Pressure	70~120 psi

Model No	Fastener Range
PM3164	3.1 - 4.1 mm x 1-1/2", 2", 2-1/2"
PM3160	3.1 - 4.1 mm x 40, 50, 60 mm

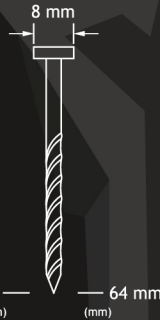

APPLICATION

- Metal connector strips
- Joist hangers
- Framing
- Trusses
- Decking

FEATURES

- 360 Degrees adjustable deflector
- Rear loading
- Positive nail setting design
- In line magazine, balance and convenient
- Powerful to shoot 65mm long nails
- Patented air sequential system
- Patented air control single firing, no double shooting

Framing Nailer

Model No: 21160FNCA3, 28160FNCA3



Model No	21160FNCA3	28160FNCA3
L x W x H	580x159x530 mm	
Weight	5.5 kgs	
Nail Shank Dia	3.8~5.0 mm	
Length	Smooth : 100~160 mm Ring, screw : 100~130 mm	
Nail Angle	21°	28°
Capacity	56~70 pcs	
Operating Pressure	70~110 psi	
Collated Type	Plastic	

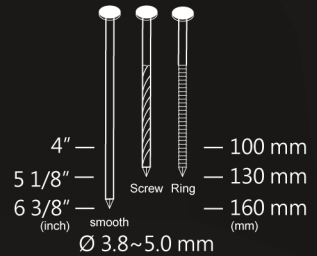

APPLICATION

- Roof to ceiling connections
- Framing, siding, sub flooring
- Timber frames
- Log homes
- Pole barns

FEATURES

- Forward exhaust
- Cylinder designed to made it more powerful
- Narrow nose for accurate fastening
- Fast and easy loading
- Adjustable depth control

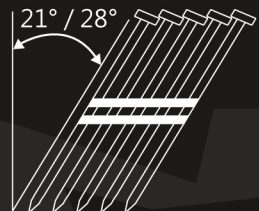

Framing Nailer

Model No: 21130FNCA3, 28130FNCA3



Model No	21130FNCA3	28130FNCA3
L x W x H	560x159x440 mm	
Weight	5.2 kgs	
Nail Shank Dia	3.3~4.2 mm	
Length	Smooth : 80~130 mm Ring, screw : 80~100 mm	
Nail Angle	21°	28°
Capacity	56~70 pcs	
Operating Pressure	70~110 psi	
Collated Type	Plastic	

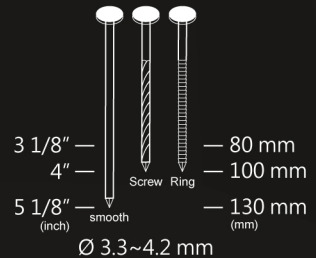

APPLICATION

- Roof to ceiling connections
- Framing, siding, sub flooring
- Timber frames
- Log homes
- Pole barns

FEATURES

- Forward exhaust
- Cylinder designed to make it more powerful
- Narrow nose for accurate fastening
- Fast and easy loading
- Adjustable depth control

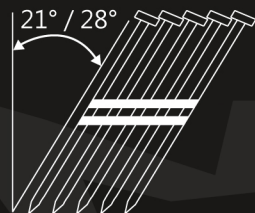

Framing Nailer

Model No: 34130FNCA3



Model No	34130FNCA3
L x W x H	560x159x440 mm
Weight	5.2 kgs
Nail Shank Dia	3.3~4.2 mm
Length	Smooth : 80~130 mm Ring, screw : 80~100 mm
Nail Angle	34°
Capacity	56~70 pcs
Operating Pressure	70~110 psi
Collated Type	Paper

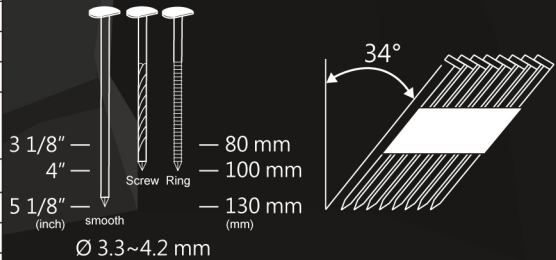

APPLICATION

- Roof to ceiling connections
- Framing, siding, sub flooring
- Timber frames
- Log homes
- Pole barns

FEATURES

- Forward exhaust
- Cylinder designed to make it more powerful
- Narrow nose for accurate fastening
- Fast and easy loading
- Adjustable depth control

Framing Nailer

Model No: 21100FNCA3

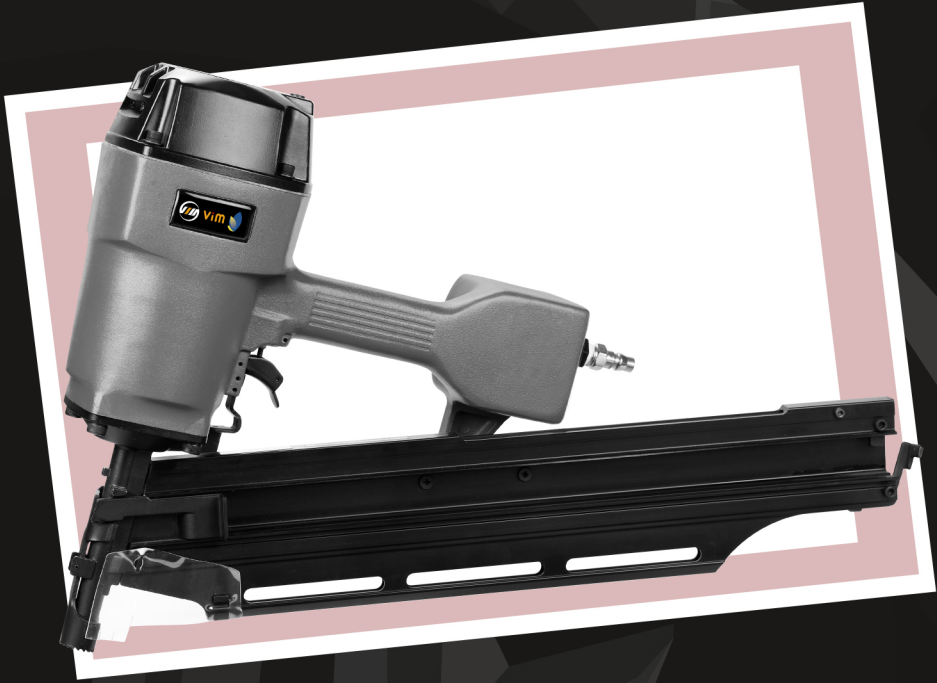

Model No	21100FNCA3
L x W x H	580x150x385 mm
Weight	5.0 kgs
Nail Shank Dia	2.9~3.4 mm
Length	Smooth : 65~100 mm Ring, screw : 65~90 mm
Nail Angle	21°
Capacity	56~70 pcs
Operating Pressure	70~110 psi
Collated Type	Plastic

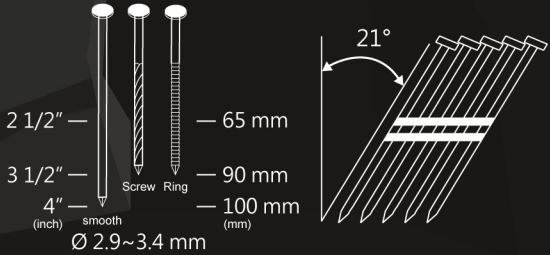

APPLICATION

- Framing
- Sheathing application including engineered lumber

FEATURES

- Forward exhaust
- Extra large cylinder design, more powerful
- Easy fast top loading
- Adjustable depth control

Framing Nailer

Model No: 1790FNCA3, 2190FNCA3

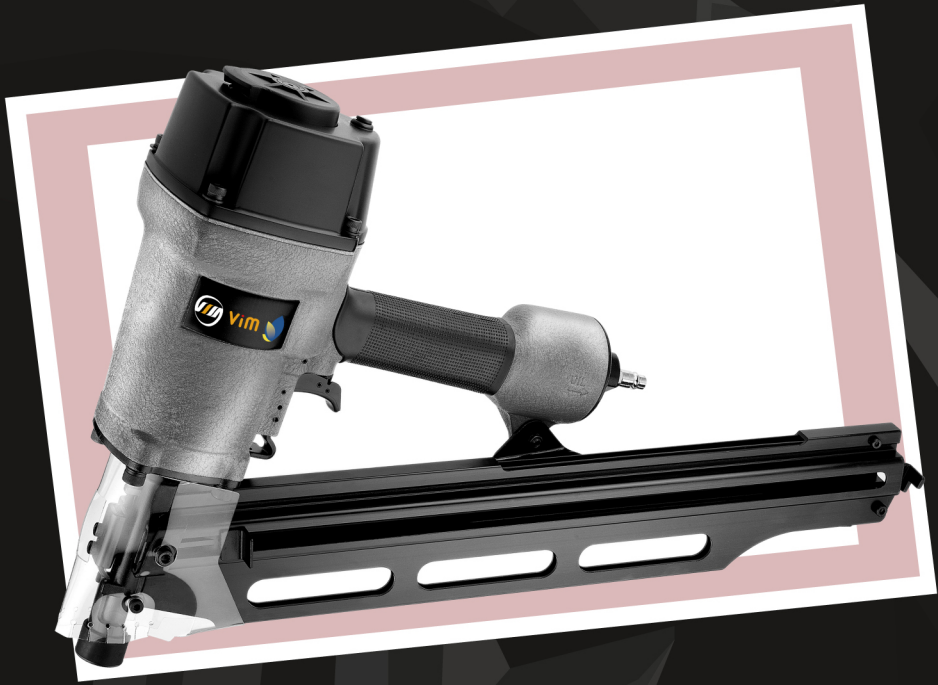

Model No	1790FNCA3	2190FNCA3
L x W x H	545x127x350 mm	
Weight	3.7 kgs	
Nail Shank Dia	2.9~3.3 mm	
Length	Smooth : 50~90 mm Ring, screw : 50~83 mm	
Nail Angle	17°	21°
Capacity	56~70 pcs	
Operating Pressure	70~110 psi	
Collated Type	Plastic	

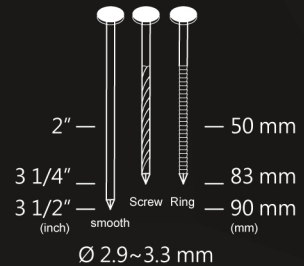

APPLICATION

- Installing metal connectors
- Framing
- Sheathing
- Exterior decks
- Siding
- Trusses
- Bridging
- Wood to masonry
- Engineered lumber
- Strapping
- Fencing

FEATURES

- 360-degree adjustable exhaust port
- Lightweight magnesium
- Fast top loading
- Adjustable depth control



Framing Nailer

Model No: 2890FNCA3, 3490FNCA3

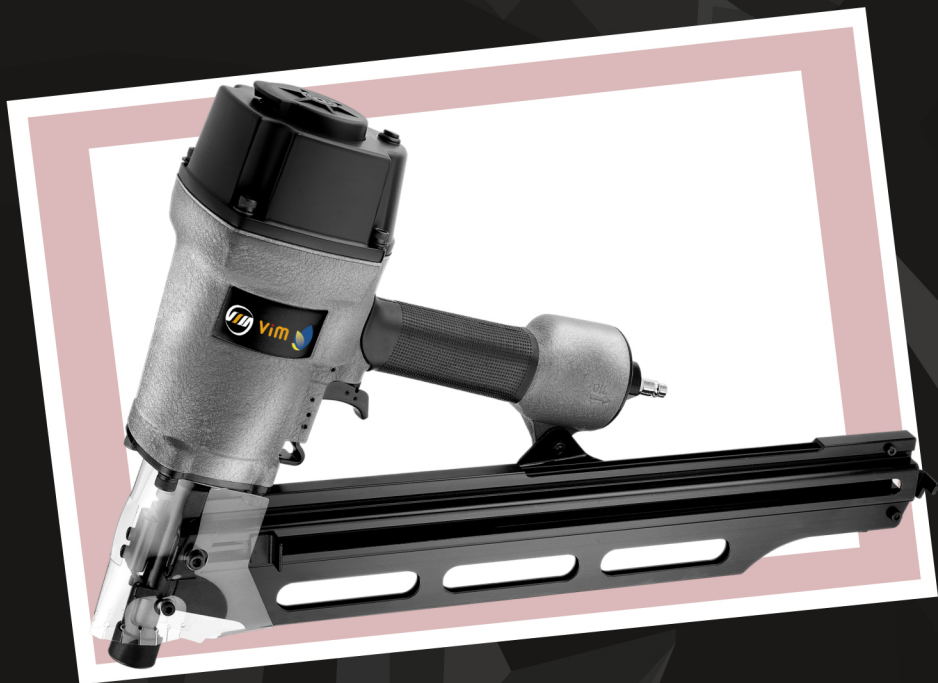

Model No	2890FNCA3	3490FNCA3
L x W x H	545x127x350 mm	
Weight	3.7 kgs	
Nail Shank Dia	2.9~3.3 mm	
Length	Smooth : 50~90 mm Ring, screw : 50~83 mm	
Nail Angle	28°	34°
Capacity	75~105 pcs	
Operating Pressure	70~110 psi	
Collated Type	Paper / Wire	

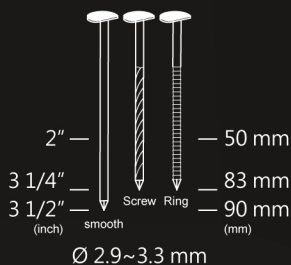

APPLICATION

- Installing metal connectors
- Framing
- Sheathing
- Exterior decks
- Siding
- Trusses
- Bridging
- Wood to masonry
- Engineered lumber
- Strapping
- Fencing

FEATURES

- 360-degree adjustable exhaust port
- Lightweight magnesium
- Fast top loading
- Adjustable depth control

