

Manual Carton Staplers

Model No: MCSH Series

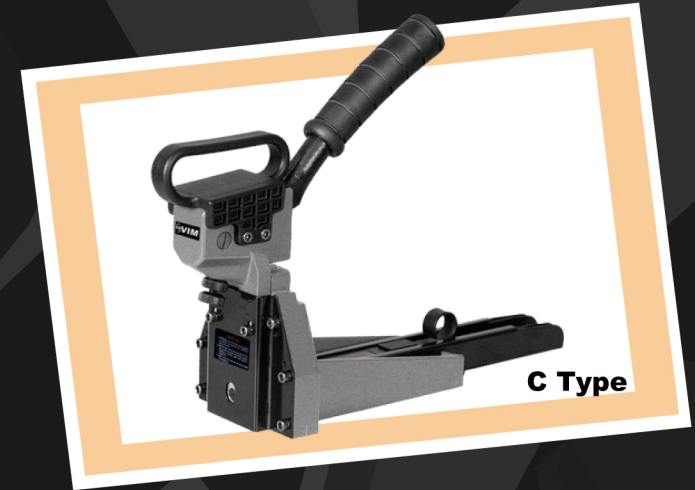

Type	A Type	B Type	C Type
L x W x H	390x115x295 mm	470x115x285 mm	400x115x285 mm
Weight	1.90 kgs	2.32 kgs	2.34 kgs

Model No	Crown(A)	Width(B)xThickness(C)	Length(D)	Capacity
MCSH3518A / MCSH3518B / MCSH3518C	34.7 mm	0.9x2.3 mm	15, 18 mm	100 pcs
MCSH3419A / MCSH3419B / MCSH3419C	34.0 mm	0.9x2.3 mm	16, 19 mm	100 pcs
MCSH3218A / MCSH3218B / MCSH3218C	32.0 mm	0.9x1.9 mm	15, 18 mm	100 pcs
MCSH743718A / MCSH743718B / MCSH743718C	34.5 mm	0.9x1.9 mm	15, 18 mm	100 pcs
MCSH904018A / MCSH904018B / MCSH904018C	34.5 mm	0.9x2.3 mm	15, 18 mm	100 pcs
MCSH3522A / MCSH3522B / MCSH3522C	34.7 mm	0.9x2.3 mm	18, 22 mm	100 pcs

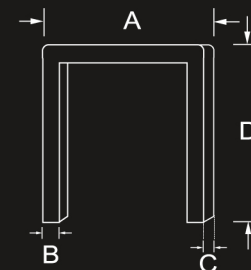

APPLICATION

- For closing filled folding boxes made of strong double and triple corrugated cardboard

FEATURES

- Easy to close cartons
- Sturdy enough for heavy users
- Durable that can seal thousands of boxes without any maintenance

Manual Carton Staplers

Model No: MCS Series

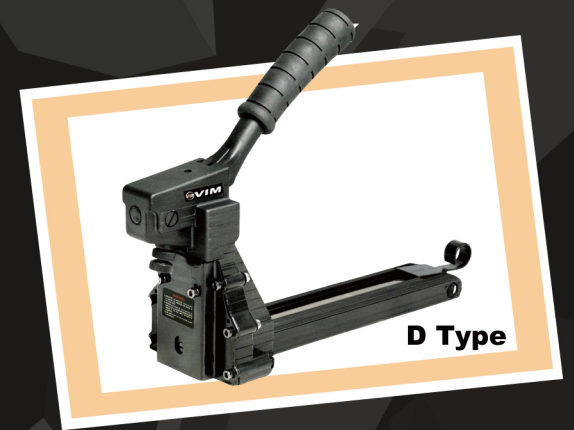
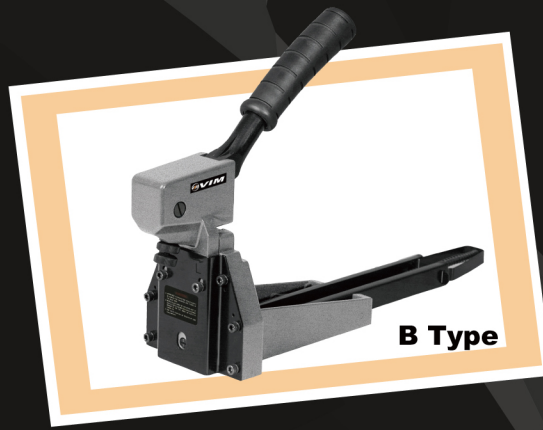
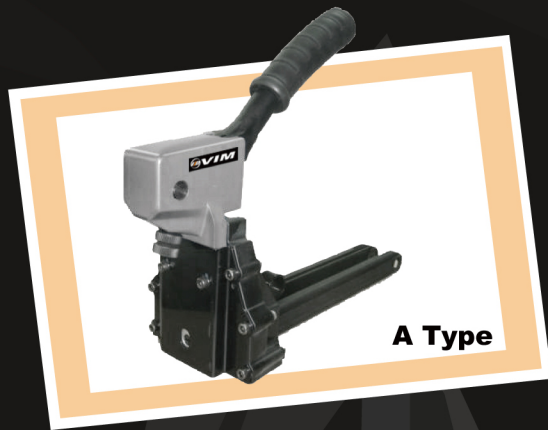

Type	A Type	B Type	C Type	D Type
L x W x H	390x115x295 mm	433x115x285 mm	360x115x295 mm	390x115x295 mm
Weight	1.90 kgs	2.30 kgs	2.26 kgs	1.90 kgs

Model No	Crown(A)	Width(B)xThickness(C)	Length(D)	Capacity
MCS3518A / MCS3518B / MCS3518C / MCS3518D	34.7 mm	0.9x2.3 mm	15, 18 mm	100 pcs
MCS3419A / MCS3419B / MCS3419C / MCS3419D	34.0 mm	0.9x2.3 mm	16, 19 mm	100 pcs
MCS3218A / MCS3218B / MCS3218C / MCS3218D	32.0 mm	0.9x1.9 mm	15, 18 mm	100 pcs
MCS743718A / MCS743718B / MCS743718C / MCS743718D	34.5 mm	0.9x1.9 mm	15, 18 mm	100 pcs
MCS904018A / MCS904018B / MCS904018C / MCS904018D	34.5 mm	0.9x2.3 mm	15, 18 mm	100 pcs
MCS3522A / MCS3522B / MCS3522C / MCS3522D	34.7 mm	0.9x2.3 mm	18, 22 mm	100 pcs

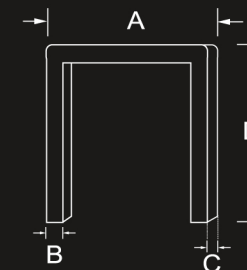

APPLICATION

- For closing filled folding boxes made of strong double and triple corrugated cardboard

FEATURES

- Easy to close cartons
- Sturdy enough for heavy users
- Durable that can seal thousands of boxes without any maintenance

Pneumatic Carton Staplers

Model No: PCS Series

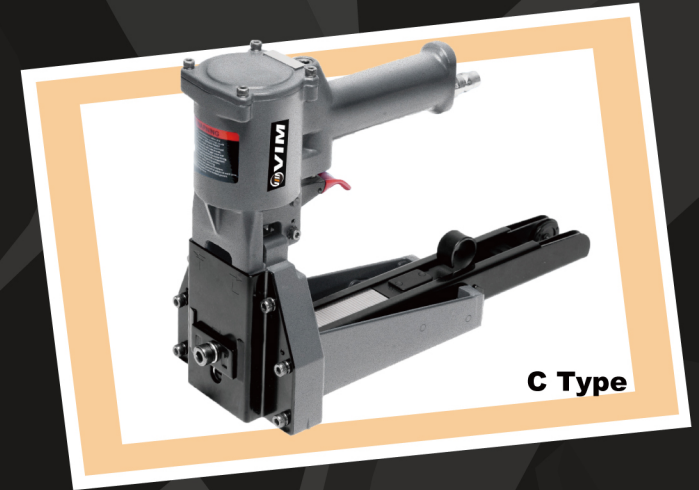
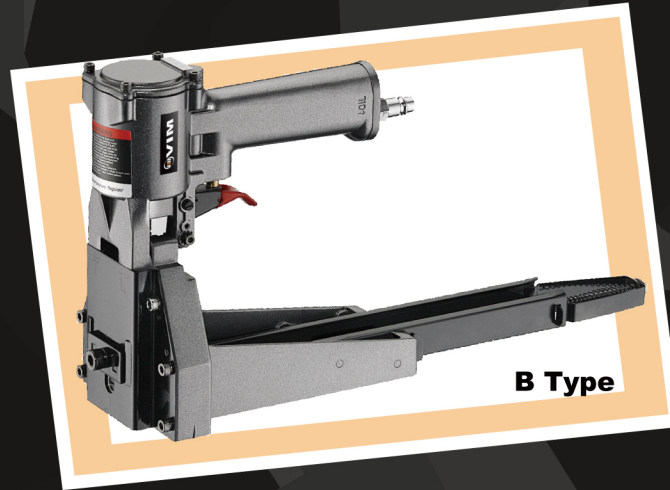

Type	A Type	B Type	C Type
L x W x H	415x115x220 mm	415x115x220 mm	325x115x225 mm
Weight	2.65 kgs	2.65 kgs	2.48 kgs
Working Pressure	70~100 psi	70~100 psi	70~100 psi

Model No	Crown(A)	Width(B)xThickness(C)	Length(D)	Capacity
PCS3518A / PCS3518B / PCS3518C	34.7 mm	0.9x2.3 mm	15, 18 mm	100 pcs
PCS3419A / PCS3419B / PCS3419C	34.0 mm	0.9x2.3 mm	16, 19 mm	100 pcs
PCS3218A / PCS3218B / PCS3218C	32.0 mm	0.9x1.9 mm	15, 18 mm	100 pcs
PCS743718A / PCS743718B / PCS743718C	34.5 mm	0.9x1.9 mm	15, 18 mm	100 pcs
PCS904018A / PCS904018B / PCS904018C	34.5 mm	0.9x2.3 mm	15, 18 mm	100 pcs
PCS3522A / PCS3522B / PCS3522C	34.7 mm	0.9x2.3 mm	18, 22 mm	100 pcs

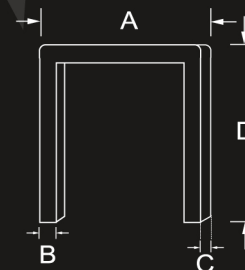

APPLICATION

- For closing filled folding boxes made of strong double and triple corrugated cardboard

FEATURES

- Easy to close cartons
- High speed and efficiency
- Sturdy enough for heavy users
- Adjustable clinching and penetration of the staple
- Durable that can seal thousands of boxes without any maintenance



Pneumatic Coil Carton Staplers

Model No: PCIRR3218, PCIGR3218, PCIRR3222, PCS3418, PCT3218



Carton Closing Roll Staples

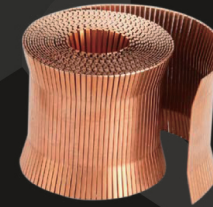

I Series

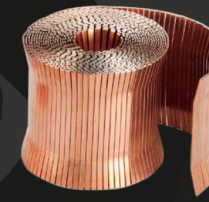

S Series



T Series

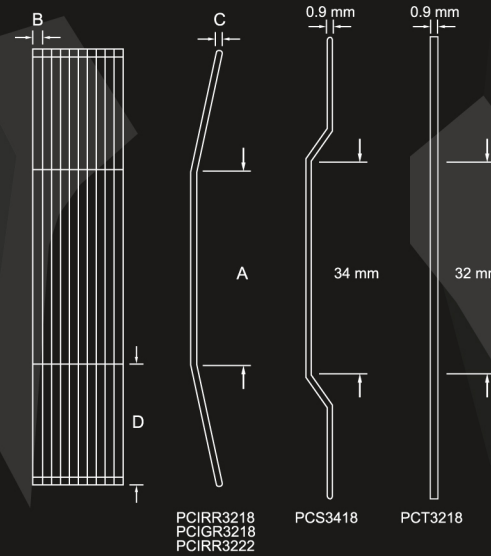

L x W x H	233x115x230 mm
Weight	2.38 kgs
Working Pressure	70~100 psi

Model No	Crown(A)	Staple Series	Width(B)xThickness(C)	Length(D)	Capacity
PCIRR3218	32 mm	I Series	0.9 x 1.9 mm	15, 18 mm	1000 pcs
PCIGR3218	32 mm	I Series	0.9 x 2.3 mm	15, 18 mm	1000 pcs
PCIRR3222	32 mm	I Series	0.9 x 2.3 mm	18, 22 mm	1000 pcs
PCS3418	34 mm	S Series	0.9 x 1.9 mm	15, 18 mm	1000 pcs
PCT3218	32 mm	T Series	0.9 x 1.9 mm	15, 18 mm	1000 pcs

APPLICATION

- Small to medium box closure
- Ideal for overlap cartons and five panel folders
- Ideal for replacing or enhancing glue system

FEATURES

- Coil feed carton top sealer
- Drives 1000 pcs wide crown staple
- Light weight and balance for fast and efficient operation
- Adjustable clinching and penetration of the staple
- Fell cycle action for maximum speed
- Quick release to prevent jams

Pneumatic Jumbo Carton Staplers

Model No: JS3222A, JS3222B

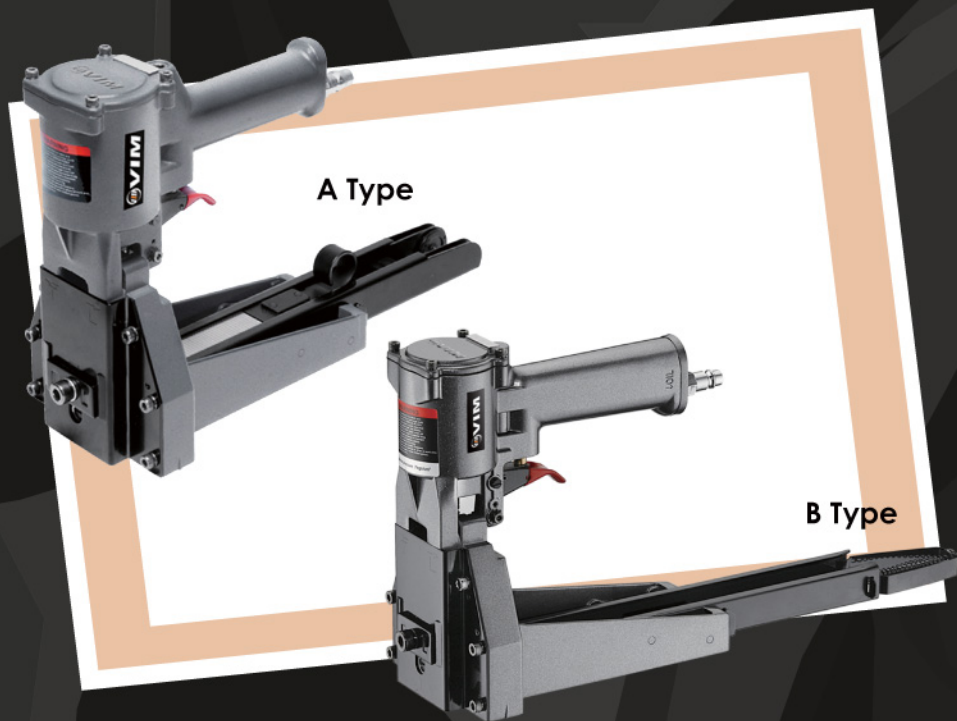

Type	A Type	B Type
L x W x H	320x115x225 mm	415x115x220 mm
Weight	2.48 kgs	2.65 kgs
Working Pressure	70~100 psi	70~100 psi

Model No	Crown(A)	Width(B)x Thickness(C)	Length(D)	Capacity
JS3222A	32 mm	1.4 x 2.3 mm	22 mm	100 pcs
JS3222B	32 mm	1.4 x 2.3 mm	22 mm	100 pcs

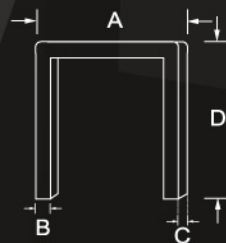

APPLICATION

- For closing filled folding boxes made of strong double & triple corrugated cardboard

FEATURES

- Portable and light
- The stapler reduces to a minimum operator fatigue

Pneumatic Jumbo Carton Staplers

Model No: JS3228, JS3235, JS3238

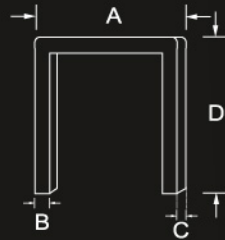

L x W x H	360x174x335 mm
Weight	6 kgs
Capacity	100 pcs
Working Pressure	70~100 psi

Model No	Crown(A)	Width(B)x Thickness(C)	Length(D)	Shape Of Staples	Position	Threading Depth
JS3228	32 mm	1.4 x 2.3 mm	25, 28 mm		6, 5	15 mm
JS3235	32 mm	1.4 x 2.3 mm	32, 35 mm		5, 4	18 mm
JS3238	32 mm	1.4 x 2.3 mm	38 mm		6	24 mm

APPLICATION

- For closing filled folding boxes made of strong double & triple corrugated cardboard
- Suitable for staples with 25mm~38mm leg length
- For cartons with 15mm~24 mm total thickness

FEATURES

- Stapler can be adjusted to different penetration depths

Wide Crown Stapling Pliers

Model No: WCS2432

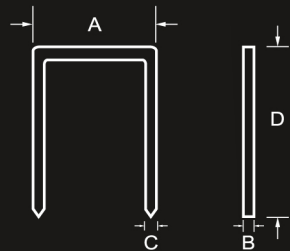

APPLICATION

- Suitable for closing large board packages, corrugated furniture wrap, stapling heavier cardboard, edge protection, closing end, etc.

FEATURES

- It can fasten up to two layers of triple wall corrugated board
- The wide crown staples offer wide solutions in many heavy-duty packaging problems, such as fixing end caps to heavy fiber transport tubes and drums or connecting edge protectors
- The WCS2432 stapling pliers has a fixed tongue, which means that it can be rapidly moved sideways

Model No	WCS2432
L x W x H	340x67x224 mm
Weight	2.5 kgs
Crown (A)	24 mm
Width(B)xThickness(C)	1.9 x 0.9 mm
Length(D)	16, 19, 22, 25, 28, 32 mm
Working Pressure	6~7 bar
Magazine Capacity	100 staples
Throat Depth	68.55 mm

Wide Crown Stapling Pliers

Model No: WCS2432L

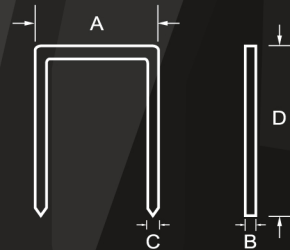

APPLICATION

- Suitable for closing large board packages, corrugated furniture wrap, stapling heavier cardboard, edge protection, closing end, etc.

FEATURES

- It can fasten up to two layers of triple wall corrugated board
- The wide crown staples offer wide solutions in many heavy-duty packaging problems, such as fixing end caps to heavy fiber transport tubes and drums or connecting edge protectors
- The WCS2432L stapling pliers has a fixed tongue, which means that it can be rapidly moved sideways

Model No	WCS2432L
L x W x H	340x67x224 mm
Weight	2.5 kgs
Crown (A)	24 mm
Width(B)xThickness(C)	1.9 x 0.9 mm
Length(D)	16, 19, 22, 25, 28, 32 mm
Working Pressure	6~7 bar
Magazine Capacity	100 staples
Throat Depth	133.3 mm

Tacker With Walking Stick

Model No: PT2432

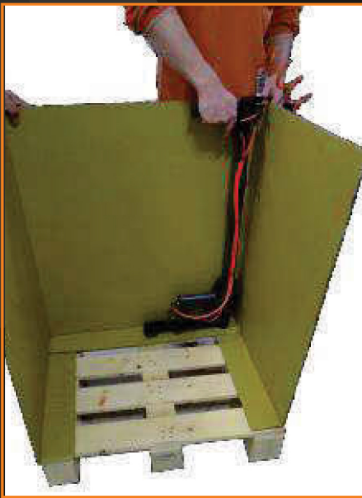
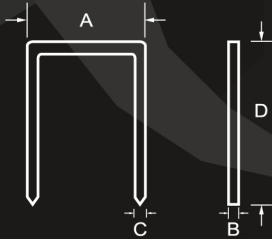

Model No	PT2432
L x W x H	352x67x841 mm
Weight	4.11 kgs
Crown (A)	24 mm
Width(B)xThickness(C)	1.9 x 0.9 mm
Length(D)	16, 19, 22, 25, 28, 32 mm
Working Pressure	6~7 bar
Magazine Capacity	100 staples

APPLICATION

- Ideal for fixing carton to pallet

FEATURES

- Single fire
- Contact safety device
- Top loading
- Walking stick extension
- Rubber grip

Pneumatic Stapling Pliers

Model No: SP103020B, SP5019B, SPSFB, SP777B, SP779B

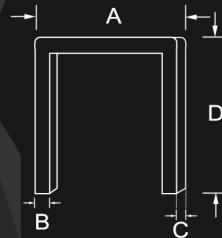
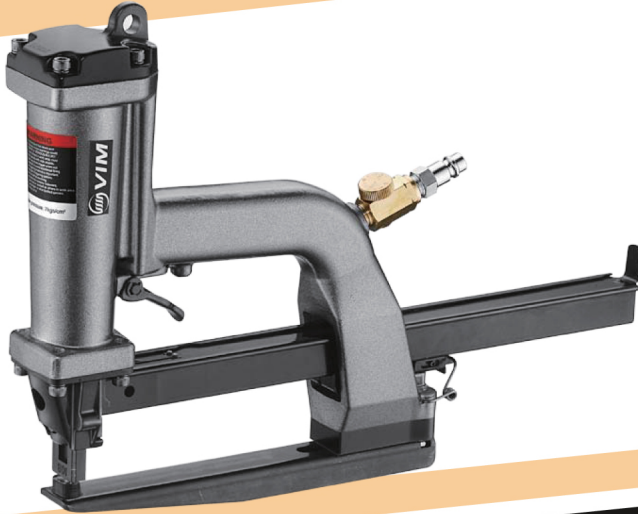

L x W x H	370x55x240 mm
Weight	2.2 kgs
Air Pressure	36~55 psi

Model No	Crown(A)	Width(B)xThickness(C)	Staples Length(D)	Magazine Capacity
SP103020B	12.95 mm	2.6 x 0.6 mm	9.5, 12.7, 15.8 mm	110 pcs
SP5019B	12.85 mm	1.27 x 0.55 mm	6.3, 9.5, 12.7, 15.8 mm	220 pcs
SPSFB	13.3 mm	1.0 x 0.72 mm	10, 13, 15 mm	280 pcs
SP777B	12.3 mm	0.65 x 2.25 mm	9.5, 12.7, 15.8 mm	140 pcs
SP779B	12.3 mm	0.63 x 1.3 mm	8, 9.5, 12.7, 14, 15.8 mm	250 pcs

APPLICATION

- Fastening corrugated containers
- Vegetable tray boxes
- End caps
- Pallet boxes
- Container inserts
- Die cut inserts
- Stapling of fabric

FEATURES

- Powerful shuttle blade provides pre-compression prior and during the stapling operation giving a strong, tight closure without breaking the corrugated surface
- High throat allows flexibility of staple placement and limits interference from obstacles such as box flanges
- C-Curved blade available for sealing partial overlap cartons
- Penetrates and securely fastens up to 2x AB flute or 4x C flute boards

Pneumatic Stapling Pliers

Model No: SP103020A,SP5019A,SPSFA,SP777A,SP779A

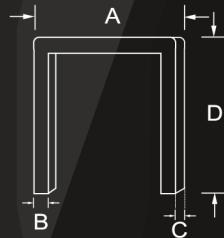
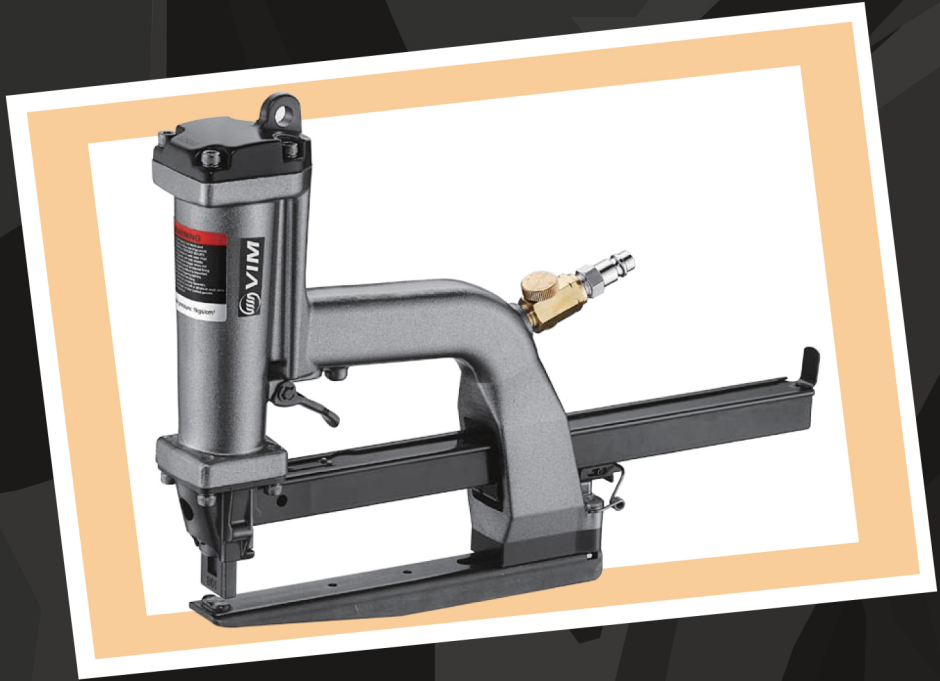

L x W x H	370x55x240 mm
Weight	2.2 kgs
Air Pressure	36~55 psi

Model No	Crown(A)	Width(B)xThickness(C)	Staples Length(D)	Magazine Capacity
SP103020A	12.95 mm	2.6 x 0.6 mm	9.5, 12.7, 15.8 mm	110 pcs
SP5019A	12.85 mm	1.27 x 0.55 mm	6.3, 9.5, 12.7, 15.8 mm	220 pcs
SPSFA	13.3 mm	1.0 x 0.72 mm	10, 13, 15 mm	280 pcs
SP777A	12.3 mm	0.65 x 2.25 mm	9.5, 12.7, 15.8 mm	140 pcs
SP779A	12.3 mm	0.63 x 1.3 mm	8, 9.5, 12.7, 14, 15.8 mm	250 pcs

APPLICATION

- Fastening corrugated containers
- Vegetable tray boxes
- End caps
- Pallet boxes
- Container inserts
- Die cut inserts
- Stapling of fabric

FEATURES

- Powerful shuttle blade provides pre-compression prior and during the stapling operation giving a strong, tight closure without breaking the corrugated surface
- High throat allows flexibility of staple placement and limits interference from obstacles such as box flanges
- C-Curved blade available for sealing partial overlap cartons
- Penetrates and securely fastens up to 2x AB flute or 4x C flute boards

Pneumatic Stapling Pliers

Model No: SP103020DR, SP5019DR, SPSFDR, SP777DR, SP779DR

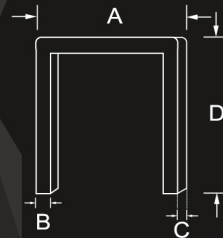
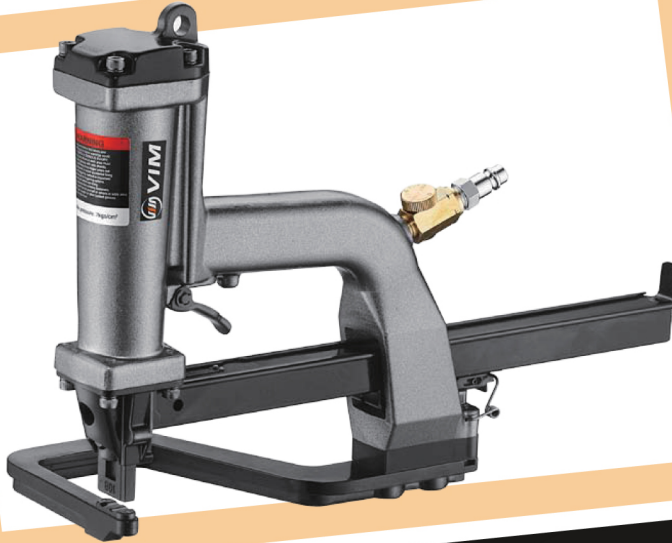

L x W x H	370x55x240 mm
Weight	2.2 kgs
Air Pressure	36~55 psi

Model No	Crown(A)	Width(B)xThickness(C)	Staples Length(D)	Magazine Capacity
SP103020DR	12.95 mm	2.6 x 0.6 mm	9.5, 12.7, 15.8 mm	110 pcs
SP5019DR	12.85 mm	1.27 x 0.55 mm	6.3, 9.5, 12.7, 15.8 mm	220 pcs
SPSFDR	13.3 mm	1.0 x 0.72 mm	10, 13, 15 mm	280 pcs
SP777DR	12.3 mm	0.65 x 2.25 mm	9.5, 12.7, 15.8 mm	140 pcs
SP779DR	12.3 mm	0.63 x 1.3 mm	8, 9.5, 12.7, 14, 15.8 mm	250 pcs

APPLICATION

- Fastening corrugated containers
- Vegetable tray boxes
- End caps
- Pallet boxes

FEATURES

- Powerful shuttle blade provides pre-compression prior and during the stapling operation giving a strong, tight closure without breaking the corrugated surface
- High throat allows flexibility of staple placement and limits interference from obstacles such as box flanges
- C-Curved blade available for sealing partial overlap cartons
- Penetrates and securely fastens up to 2x AB flute or 4x C flute boards

Pneumatic Stapling Pliers

Model No: SP103020DL, SP5019DL, SPSFDL, SP777DL, SP779DL

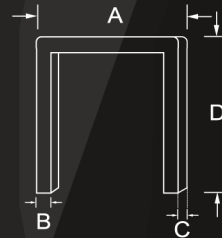
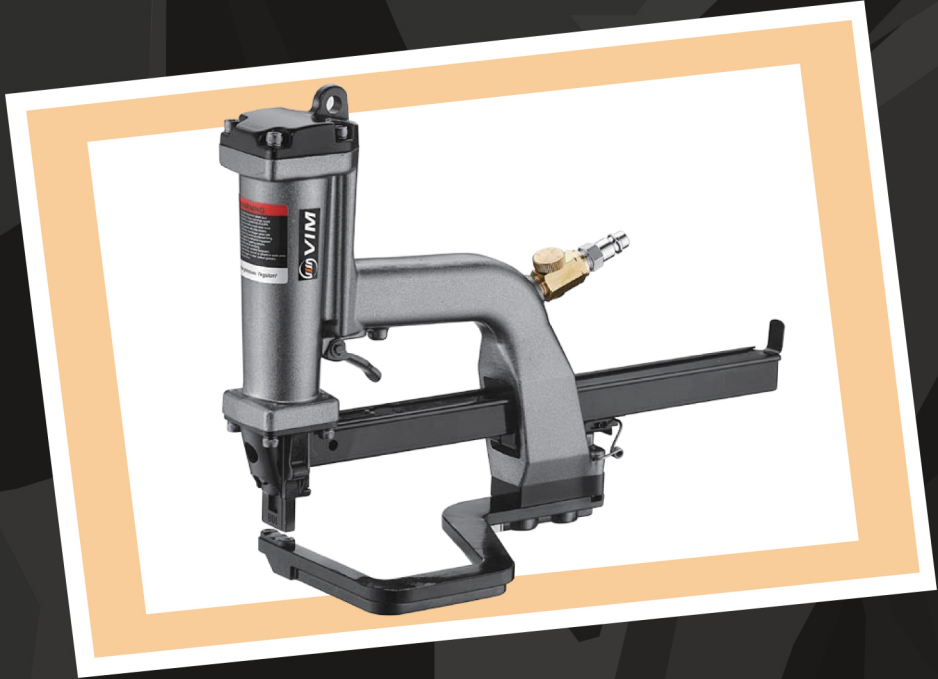

L x W x H	370x55x240 mm
Weight	2.2 kgs
Air Pressure	36~55 psi

Model No	Crown(A)	Width(B)xThickness(C)	Staples Length(D)	Magazine Capacity
SP103020DL	12.95 mm	2.6 x 0.6 mm	9.5, 12.7, 15.8 mm	110 pcs
SP5019DL	12.85 mm	1.27 x 0.55 mm	6.3, 9.5, 12.7, 15.8 mm	220 pcs
SPSFDL	13.3 mm	1.0 x 0.72 mm	10, 13, 15 mm	280 pcs
SP777DL	12.3 mm	0.65 x 2.25 mm	9.5, 12.7, 15.8 mm	140 pcs
SP779DL	12.3 mm	0.63 x 1.3 mm	8, 9.5, 12.7, 14, 15.8 mm	250 pcs

APPLICATION

- Fastening corrugated containers
- Vegetable tray boxes
- End caps
- Pallet boxes

FEATURES

- Powerful shuttle blade provides pre-compression prior and during the stapling operation giving a strong, tight closure without breaking the corrugated surface
- High throat allows flexibility of staple placement and limits interference from obstacles such as box flanges
- C-Curved blade available for sealing partial overlap cartons
- Penetrates and securely fastens up to 2x AB flute or 4x C flute boards

Pneumatic Stapling Pliers

Model No: SP103020CR, SP5019CR, SPSFCR, SP777CR, SP779CR

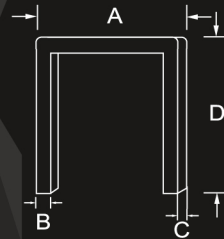

L x W x H	370x55x240 mm
Weight	2.2 kgs
Air Pressure	36~55 psi

Model No	Crown(A)	Width(B)xThickness(C)	Staples Length(D)	Magazine Capacity
SP103020CR	12.95 mm	2.6 x 0.6 mm	9.5, 12.7, 15.8 mm	110 pcs
SP5019CR	12.85 mm	1.27 x 0.55 mm	6.3, 9.5, 12.7, 15.8 mm	220 pcs
SPSFCR	13.3 mm	1.0 x 0.72 mm	10, 13, 15 mm	280 pcs
SP777CR	12.3 mm	0.65 x 2.25 mm	9.5, 12.7, 15.8 mm	140 pcs
SP779CR	12.3 mm	0.63 x 1.3 mm	8, 9.5, 12.7, 14, 15.8 mm	250 pcs

APPLICATION

- Fastening corrugated containers
- Vegetable tray boxes
- End caps
- Pallet boxes

FEATURES

- Powerful shuttle blade provides pre-compression prior and during the stapling operation giving a strong tight closure without breaking the corrugated surface
- High throat allows flexibility of staple placement and limits interference from obstacles such as box flanges
- C-Curved blade available for sealing partial overlap cartons
- Penetrates and securely fastens up to 2x AB flute or 4x C flute boards

Pneumatic Stapling Pliers

Model No: SP103020CL, SP5019CL, SPSFCL, SP777CL, SP779CL

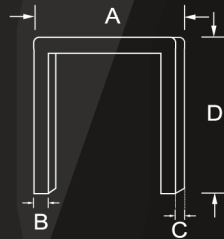
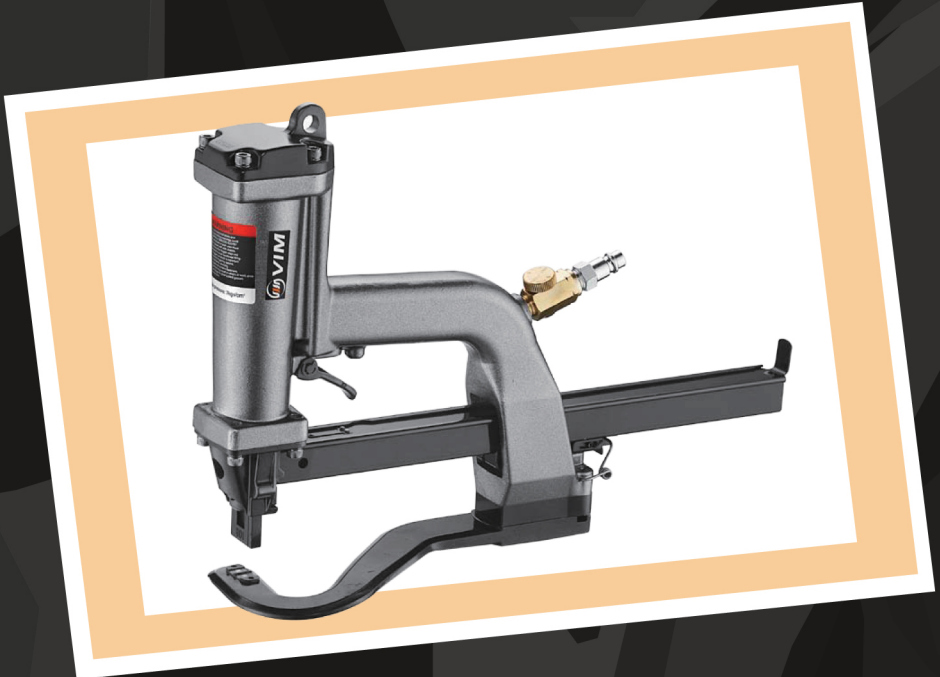

L x W x H	370x55x240 mm
Weight	2.2 kgs
Air Pressure	36~55 psi

Model No	Crown(A)	Width(B)xThickness(C)	Staples Length(D)	Magazine Capacity
SP103020CL	12.95 mm	2.6 x 0.6 mm	9.5, 12.7, 15.8 mm	110 pcs
SP5019CL	12.85 mm	1.27 x 0.55 mm	6.3, 9.5, 12.7, 15.8 mm	220 pcs
SPSFCL	13.3 mm	1.0 x 0.72 mm	10, 13, 15 mm	280 pcs
SP777CL	12.3 mm	0.65 x 2.25 mm	9.5, 12.7, 15.8 mm	140 pcs
SP779CL	12.3 mm	0.63 x 1.3 mm	8, 9.5, 12.7, 14, 15.8 mm	250 pcs

APPLICATION

- Fastening corrugated containers
- Vegetable tray boxes
- End caps
- Pallet boxes

FEATURES

- Powerful shuttle blade provides pre-compression prior and during the stapling operation giving a strong, tight closure without breaking the corrugated surface
- High throat allows flexibility of staple placement and limits interference from obstacles such as box flanges
- C-Curved blade available for sealing partial overlap cartons
- Penetrates and securely fastens up to 2x AB flute or 4x C flute boards

Foot Operated Bottomer

Model No: FB3522, FB3422, FB3222, FB743718, FB904022, FB1618

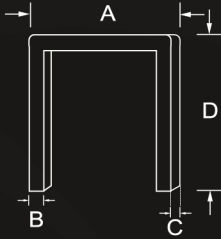

L x W x H	910x600x1245 mm
Weight	26.8 kgs
Working Height	950 mm
Throat Depth	320 mm

Model No	Crown(A)	Width(B)xThickness(C)	Length(D)	Capacity
FB3522	34.7 mm	0.9 x 2.3 mm	15, 18, 22 mm	200 pcs
FB3422	34 mm	0.9 x 2.3 mm	16, 19, 22 mm	200 pcs
FB3222	32 mm	0.9 x 1.9 mm	15, 18, 22 mm	200 pcs
FB743718	34.5 mm	0.9 x 1.9 mm	15, 18 mm	200 pcs
FB904022	34.5 mm	0.9 x 2.3 mm	15, 18, 22 mm	200 pcs
FB1618	16 mm	0.6 x 1.8 mm	8, 15, 18 mm	200 pcs

APPLICATION

- Bottom stapling
- Transport packing

FEATURES

- Satisfy the simplest exigencies in cardboard bottom sealing
- Suitable for different locations
- Easy-staple-loading design for fast staple loading
- Short ergonomic foot pedal designed for speed and easy actuation
- Robust with steel tubing frame and wearing parts of hardened steel

Foot Operated Bottomer

Model No: HFB3522, HFB3222

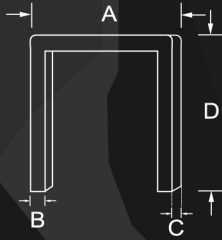

L x W x H	979x732x1315 mm
Weight	44.26 kgs
Working Height	1085 mm
Throat Depth	394 mm

Model No	Crown(A)	Width(B)xThickness(C)	Length(D)	Capacity
HFB3522	34.7 mm	0.9 x 2.3 mm	15, 18, 22 mm	300 pcs
HFB3222	32 mm	0.9 x 1.9 mm	15, 18, 22 mm	300 pcs

APPLICATION

- Bottom stapling
- Transport packing

FEATURES

- Satisfy the simplest exigencies in cardboard bottom sealing
- Suitable for different locations
- Easy-staple-loading design for fast staple loading
- Short ergonomic foot pedal designed for speed and easy actuation
- Robust with steel tubing frame and wearing parts of hardened steel

Foot Operated Bottomer

Model No: HFB5315

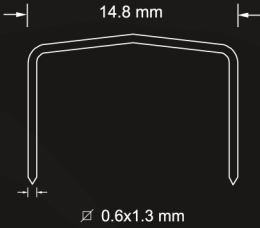

L x W x H	930x732x1280 mm
Weight	44.26 kgs
Working Height	1085 mm
Throat Depth	394 mm

Model No	Crown	Width x Thickness	Length	Capacity
HFB5315	14.8 mm	0.6 x 1.3 mm	6, 9, 12, 15 mm	315 pcs

APPLICATION

- Bottom stapling
- Transport packing

FEATURES

- Satisfy the simplest exigencies in cardboard bottom sealing
- Suitable for different locations
- Easy-staple-loading design for fast staple loading
- Short ergonomic foot pedal designed for speed and easy actuation
- Robust with steel tubing frame and wearing parts of hardened steel

Foot Operated Side Bottomer

Model No: FSB3522, FSB3422, FSB3222, FSB743718,
FSB904022, FSB1618

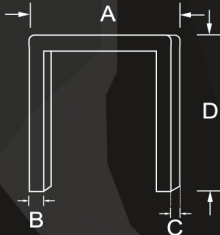

L x W x H	910x600x1245 mm
Weight	24.6 kgs
Working Height	950 mm
Throat Depth	320 mm

Foot Operated Side Bottomers

Model No	Crown(A)	Width(B)xThickness(C)	Length(D)	Capacity
FSB3522	34.7 mm	0.9 x 2.3 mm	15, 18, 22 mm	200 pcs
FSB3422	34 mm	0.9 x 2.3 mm	16, 19, 22 mm	200 pcs
FSB3222	32 mm	0.9 x 1.9 mm	15, 18, 22 mm	200 pcs
FSB743718	34.5 mm	0.9 x 1.9 mm	15, 18 mm	200 pcs
FSB904022	34.5 mm	0.9 x 2.3 mm	15, 18, 22 mm	200 pcs
FSB1618	16 mm	0.6 x 1.8 mm	18, 15, 18 mm	200 pcs

APPLICATION

- Bottom stapling
- Transport packing

FEATURES

- Seals 50 to 100 cation bottoms per hour
- The use of a pneumatic bottomer is advisable
- Equipped with a safety foot pedal
- Easy-staple-loading design for fast staple loading
- Short ergonomic foot pedal designed for speed and easy actuation
- Robust with steel tubing frame and wearing parts of hardened steel

Foot Operated Side Bottomer

Model No: HFSB3522, HFSB3222

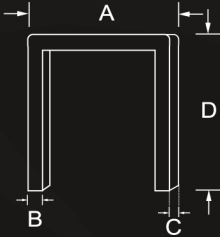

L x W x H	979x732x1315 mm
Weight	44.26 kgs
Working Height	1085 mm
Throat Depth	394 mm

Foot Operated Side Bottomer Staplers

Model No	Crown(A)	Width(B)xThickness(C)	Length(D)	Capacity
HFSB3522	34.7 mm	0.9 x 2.3 mm	15, 18, 22 mm	300 pcs
HFSB3222	32 mm	0.9 x 1.9 mm	15, 18, 22 mm	300 pcs

APPLICATION

- Bottom stapling
- Transport packing

FEATURES

- Seals 50 to 100 cation bottoms per hour
- The use of a pneumatic bottomer is advisable
- Equipped with a safety foot pedal
- Easy-staple-loading design for fast staple loading
- Short ergonomic foot pedal designed for speed and easy actuation
- Robust with steel tubing frame and wearing parts of hardened steel

Foot Operated Side Bottomer

Model No: HF5B5315

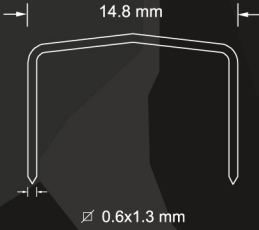

L x W x H	930x732x1315 mm
Weight	44.26 kgs
Working Height	1085 mm
Throat Depth	394 mm

Model No	Crown	Width x Thickness	Length	Capacity
HF5B5315	14.8 mm	0.6 x 1.3 mm	6, 9, 12, 15 mm	315 pcs

APPLICATION

- Bottom stapling
- Transport packing

FEATURES

- Seals 50 to 100 cation bottoms per hour
- The use of a pneumatic bottomer is advisable
- Equipped with a safety foot pedal
- Easy-staple-loading design for fast staple loading
- Short ergonomic foot pedal designed for speed and easy actuation
- Robust with steel tubing frame and wearing parts of hardened steel

Pneumatic Bottomer

Model No: PB3522, PB3422, PB3222, PB743718,
PB904022, PB1618

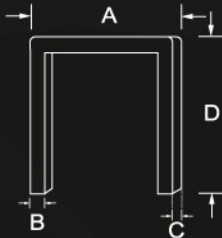

L x W x H	830x600x1245 mm
Weight	29.3 kgs
Working Height	950 mm
Throat Depth	320 mm
Working Pressure	70~90 psi

Pneumatic Bottomers

Model No	Crown(A)	Width(B)xThickness(C)	Length(D)	Capacity
PB3522	34.7 mm	0.9 x 2.3 mm	15, 18, 22 mm	200 pcs
PB3422	34 mm	0.9 x 2.3 mm	16, 19, 22 mm	200 pcs
PB3222	32 mm	0.9 x 1.9 mm	15, 18, 22 mm	200 pcs
PB743718	34.5 mm	0.9 x 1.9 mm	15, 18 mm	200 pcs
PB904022	34.5 mm	0.9 x 2.3 mm	15, 18, 22 mm	200 pcs
PB1618	16 mm	0.6 x 1.8 mm	8, 12, 15, 18 mm	200 pcs

APPLICATION

- Bottom stapling
- Transport packing

FEATURES

- When the production output requires sealing of 50 to 100 cation bottoms per hour
- The use of a pneumatic bottomer is advisable
- This model is equipped with a safety foot pedal
- Easy Staple load design for fast staple loading
- Short ergonomic foot pedal designed for speed and easy actuation
- Robust with steel tubing frame and wearing parts of hardened steel

Pneumatic Bottomer

Model No: HPB3522, HPB3222

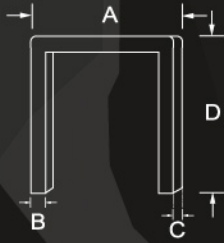

L x W x H	985x732x1360 mm
Weight	46.33 kgs
Working Height	1085 mm
Throat Depth	394 mm
Working Pressure	70~90 psi

Heavy Duty Pneumatic Bottomers

Model No	Crown	Width x Thickness	Length	Capacity
HPB3522	34.7 mm	0.9 x 2.3 mm	15, 18, 22 mm	300 pcs
HPB3222	32 mm	0.9 x 1.9 mm	15, 18, 22 mm	300 pcs

APPLICATION

- Bottom stapling
- Transport packing

FEATURES

- When the production output requires sealing of 50 to 100 cation bottoms per hour
- The use of a pneumatic bottomer is advisable
- This model is equipped with a safety foot pedal
- Easy Staple load design for fast staple loading
- Short ergonomic foot pedal designed for speed and easy actuation
- Robust with steel tubing frame and wearing parts of hardened steel

Pneumatic Side Bottomer

Model No: HPB5315

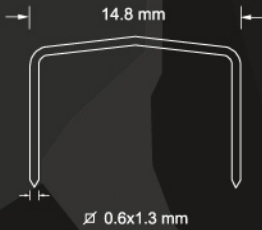

L x W x H	985x732x1360 mm
Weight	46.33 kgs
Working Height	1085 mm
Throat Depth	394 mm
Working Pressure	70~90 psi

Model No	Crown	Width x Thickness	Length	Capacity
HPB5315	14.8 mm	0.6 x 1.3 mm	6, 9, 12, 15 mm	315 pcs

APPLICATION

- Bottom stapling
- Transport packing

FEATURES

- When the production output requires sealing of 0 to 101 cation bottoms per hour
- The use of a pneumatic bottomer is advisable
- This model is equipped with a safety foot pedal
- Easy Staple load design for fast staple loading
- Short ergonomic foot pedal designed for speed and easy actuation
- Robust with steel tubing frame and wearing parts of hardened steel

Pneumatic Side Bottomer

Model No: HPSB3522, HPSB3222

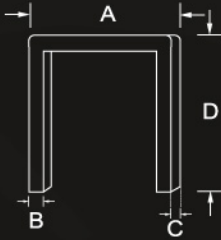

L x W x H	985x732x1360 mm
Weight	46.33 kgs
Working Height	1085 mm
Throat Depth	394 mm
Carton Height	1085 mm

Pneumatic Side Bottomers

Model No	Crown(A)	Width(B)xThickness(C)	Length(D)	Capacity	Working Pressure
HPSB3522	34.7 mm	0.9 x 2.3 mm	15, 18, 22 mm	300 pcs	70~90 psi
HPSB3222	32 mm	0.9 x 1.9 mm	15, 18, 22 mm	300 pcs	70~90 psi

APPLICATION

- Bottom stapling
- Transport packing

FEATURES

- When the production output requires sealing of 0 to 101 carton bottoms per hour
- The use of a pneumatic bottomer is advisable
- This model is equipped with a safety foot pedal
- Easy staple load design for fast staple loading
- Short ergonomic foot pedal designed for speed and easy actuation
- Robust with steel tubing frame and wearing parts of hardened steel

Pneumatic Side Bottomer

Model No: HPSB5315

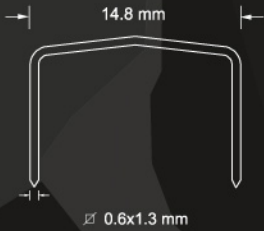

L x W x H	985x732x1360 mm
Weight	46.33 kgs
Working Height	1085 mm
Throat Depth	394 mm

Model No	Crown	Width x Thickness	Length	Capacity
HPSB5315	14.8 mm	0.6 x 1.3 mm	6, 9, 12, 15 mm	315 pcs

APPLICATION

- Bottom stapling
- Transport packing

FEATURES

- When the production output requires sealing of 0 to 101 caton bottoms per hour
- The use of a pneumatic bottomer is advisable
- This model is equipped with a safety foot pedal
- Easy staple load design for fast staple loading
- Short ergonomic foot pedal designed for speed and easy actuation
- Robust with steel tubing frame and wearing parts of hardened steel

Pneumatic Side Bottomer

Model No: PSB3522S, PSB3422S, PSB3222S, PSB743718S,
PSB904022S, PSB1618S

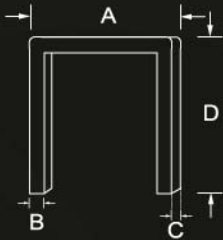

L x W x H	830x600x1245 mm
Weight	27 kgs
Max. Working Height	930 mm
Throat Depth	320 mm

Pneumatic Side Bottomers

Model No	Crown(A)	Width(B)xThickness(C)	Length(D)	Capacity	Working Pressure
PSB3522S	34.7 mm	0.9 x 2.3 mm	15, 18, 22 mm	200 pcs	70~90 psi
PSB3422S	34 mm	0.9 x 2.3 mm	16, 19, 22 mm	200 pcs	70~90 psi
PSB3222S	32 mm	0.9 x 1.9 mm	15, 18, 22 mm	200 pcs	70~90 psi
PSB743718S	34.5 mm	0.9 x 1.9 mm	15, 18 mm	200 pcs	70~90 psi
PSB904022S	34.5 mm	0.9 x 2.3 mm	15, 18, 22 mm	200 pcs	70~90 psi
PSB1618S	16 mm	0.6 x 1.8 mm	8, 12, 15, 18 mm	200 pcs	70~90 psi

APPLICATION

- Stapling sides of carton
- Transport packing

FEATURES

- When the production output requires sealing of 0 to 100 carton bottoms per hour
- The use of a pneumatic bottomer is advisable
- This model is equipped with a safety foot pedal
- Easy Staple load design for fast staple loading
- Short ergonomic foot pedal designed for speed and easy actuation
- Robust with steel tubing frame and wearing parts of hardened steel

Pneumatic Side Bottomer

Model No: PSB3522M, PSB3422M, PSB3222M, PSB743718M, PSB904022M

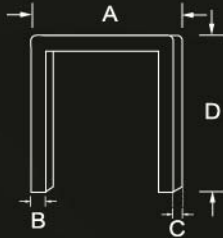

L x W x H	830x600x1550 mm
Weight	30 kgs
Max. Working Height	1250 mm
Throat Depth	320 mm

Pneumatic Side Bottomers

Model No	Crown(A)	Width(B)xThickness(C)	Length(D)	Capacity	Working Pressure
PSB3522M	34.7 mm	0.9 x 2.3 mm	15, 18, 22 mm	200 pcs	70~90 psi
PSB3422M	34 mm	0.9 x 2.3 mm	16, 19, 22 mm	200 pcs	70~90 psi
PSB3222M	32 mm	0.9 x 1.9 mm	15, 18, 22 mm	200 pcs	70~90 psi
PSB743718M	34.5 mm	0.9 x 1.9 mm	15, 18 mm	200 pcs	70~90 psi
PSB904022M	34.5 mm	0.9 x 2.3 mm	15, 18, 22 mm	200 pcs	70~90 psi

APPLICATION

- Stapling sides of carton
- Transport packing

FEATURES

- When the production output requires sealing of 0 to 101 carton bottoms per hour
- The use of a pneumatic bottomer is advisable
- This model is equipped with a safety foot pedal
- Easy staple load design for fast staple loading
- Short ergonomic foot pedal designed for speed and easy actuation
- Robust with steel tubing frame and wearing parts of hardened steel

Pneumatic Side Bottomer

Model No: PSB3522L, PSB3422L, PSB3222L, PSB743718L, PSB904022L

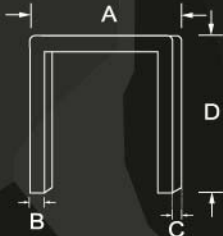

L x W x H	830x600x1850 mm
Weight	32 kgs
Max. Working Height	1520 mm
Throat Depth	320 mm

Pneumatic Side Bottomers

Model No	Crown(A)	Width(B)xThickness(C)	Length(D)	Capacity	Working Pressure
PSB3522L	34.7 mm	0.9 x 2.3 mm	15, 18, 22 mm	200 pcs	70~90 psi
PSB3422L	34 mm	0.9 x 2.3 mm	16, 19, 22 mm	200 pcs	70~90 psi
PSB3222L	32 mm	0.9 x 1.9 mm	15, 18, 22 mm	200 pcs	70~90 psi
PSB743718L	34.5 mm	0.9 x 1.9 mm	15, 18 mm	200 pcs	70~90 psi
PSB904022L	34.5 mm	0.9 x 2.3 mm	15, 18, 22 mm	200 pcs	70~90 psi

APPLICATION

- Stapling sides of carton
- Transport packing

FEATURES

- When the production output requires sealing of 0 to 101 carton bottoms per hour
- The use of a pneumatic bottomer is advisable
- This model is equipped with a safety foot pedal
- Easy staple load design for fast staple loading
- Short ergonomic foot pedal designed for speed and easy actuation
- Robust with steel tubing frame and wearing parts of hardened steel

Pneumatic Side Bottomer

Model No: PSB120,PSB150,PSB170,PSB230

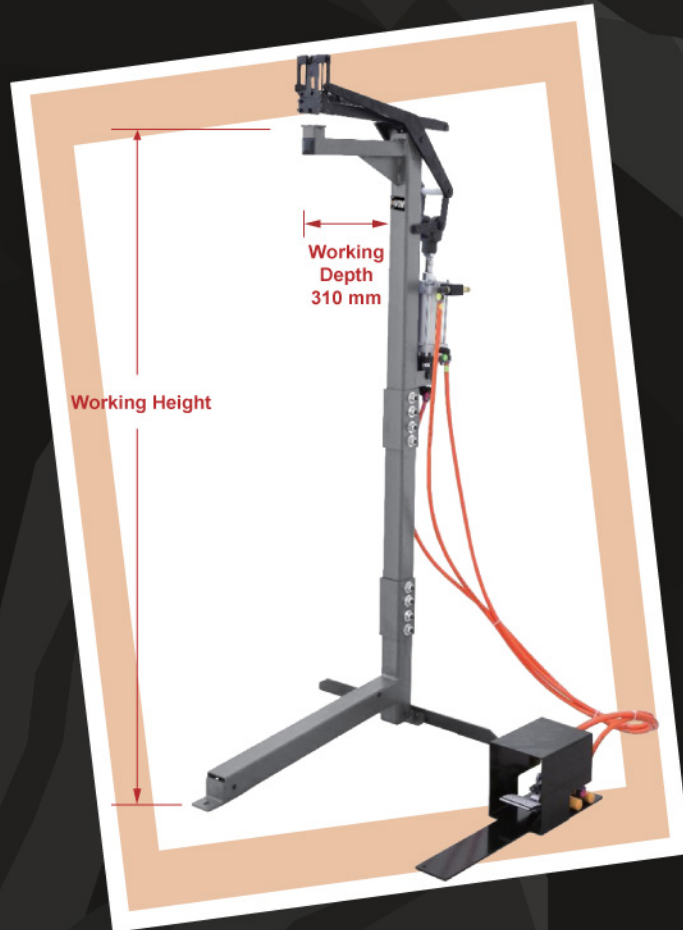

APPLICATION:

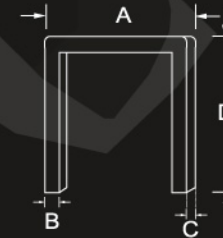

L x W x H	735x600x1620 mm
Weight	33.3 kgs
Air Pressure	5~7 kgs/cm ²

APPLICATION

- Adjustable height pneumatic side bottomer to help you with stapling large carton lid and bottoms as well as storing itself

FEATURES

- Depth and working height can be adjustable
- The use of a pneumatic bottomer is advisable
- The model is equipped with a safety foot pedal
- Easy staple load design for fast staple loading
- Short ergonomic foot pedal designed for speed and easy actuation
- Robust with steel tubing frame and wearing parts of hardened steel

Available Staplers

Model No	Crown(A)	Width(B)xThickness(C)	Length	Working Height	Working Depth
PSB12035/PSB15035/PSB17035/PSB23035	34.7 mm	0.9 x 2.3 mm	15, 18, 22 mm	1200/1500/1700/2300 mm	310 mm
PSB12032/PSB15032/PSB17032/PSB23032	32 mm	0.9 x 1.9 mm	15, 18, 22 mm	1200/1500/1700/2300 mm	310 mm
PSB12034/PSB15034/PSB17034/PSB23034	34 mm	0.9 x 2.3 mm	15, 18 mm	1200/1500/1700/2300 mm	310 mm
PSB1207437/PSB1507437/PSB1707437/PSB2307437	34.5 mm	0.9 x 1.9 mm	15, 18 mm	1200/1500/1700/2300 mm	310 mm
PSB1209040/PSB1509040/PSB1709040/PSB2309040	34.5 mm	0.9 x 2.3 mm	15, 18, 22 mm	1200/1500/1700/2300 mm	310 mm
PSB12016/PSB15016/PSB17016/PSB23016	16 mm	0.6 x 1.8 mm	8, 12, 15, 18 mm	1200/1500/1700/2300 mm	310 mm